

Epic pro



BIOLASE

ECO# 000665

Approved by:

[Signature] 09/30/2020

OFFICIAL DOCUMENT ONLY WHEN WATERMARK HERE

User Manual

PAGE LEFT BLANK

Contents

INTRODUCTION	6
1 OVERVIEW	7
2 INDICATIONS FOR USE	8
3 CONTRAINDICATIONS, WARNINGS, AND PRECAUTIONS	10
3.1 Contraindications.....	10
3.2 Warnings and Precautions	10
4 SPECIFICATIONS.....	12
4.1 General.....	12
4.2 Electrical.....	12
4.3 Laser	12
4.4 Other Light Sources	12
5 EQUIPMENT DESCRIPTION	13
5.1 System Components	13
5.2 General.....	13
Console	14
Fiber Mangement Module.....	14
Fiber Optic Cable.....	14
Surgical Handpiece.....	14
Fiber Tips.....	14
Wireless Foot Pedal.....	15
6 SAFETY WITH THE EPIC PRO	16
6.1 Safety Instructions.....	16
6.2 Safety Classification	17
6.3 Safety Features	18
7 INSTALLATION AND SETUP.....	20
7.1 Facility Requirements.....	20
7.2 System Setup	20
7.3 Fiber Optic Cable	21
7.4 Surgical Handpiece Assembly.....	22
7.5 Single-Use Tips	23
7.6 Whitening Handpiece (optional accessory).....	25
7.6.1 Whitening Gel	25
7.7 Pairing the Foot Pedal and Laser.....	26

Contents

8 OPERATING INSTRUCTIONS	27
8.1 Epic Pro Interactive Display	27
8.2 Icons-Definitions.....	27
8.3 System Start-up and Functions.....	28
8.3.1 Login.....	28
8.3.2 HOME Screen	29
8.3.3 Basic and Advanced	29
8.3.4 Treatment Modes of Operation.....	30
8.3.5 Continuous Wave (CW) Mode.....	30
8.3.6 Automatic Power Control (APC).....	31
8.3.7 Pulse Mode.....	32
8.3.8 Super Thermal Pulse.....	33
8.3.9 QUICK START	34
8.3.10 Tip Selection	35
8.3.11 Tip Warning.....	36
8.3.12 Procedure Selection	37
8.3.13 Creating Favorites Procedure.....	38
8.3.14 Selecting a Favorites Procedure	40
8.3.15 Ready Mode	40
8.3.16 Firing the Laser.....	41
8.3.17 System Settings Menu.....	42
8.3.18 System Information and Software Updates	43
8.3.19 Service Mode.....	48
8.3.20 Export and Import of Settings and Favorites	48
8.4 Turning the Epic Pro OFF.....	49
8.5 System Flow Chart.....	50
9 PRESETS	51
9.1 Restorative	51
9.2 Aesthetic.....	52
9.3 Implant.....	52
9.4 Perio.....	52
9.5 Oral LesionsI	53
9.6 Surgical	53
9.7 Endo.....	53

Contents

10 CLEANING, DISINFECTION, AND STERILIZATION	54
10.1 Cleaning the Console	54
10.2 Cleaning and Sterilization Procedures, Handpiece and Fiber Tips	54
10.3 Disinfecting the Fiber.....	56
10.4 Disinfecting the Whitening Handpiece.....	56
11 MAINTENANCE AND CALIBRATION	57
11.1 Annual Calibration	57
11.2 Changing the Wireless Foot Pedal Batteries.....	57
11.3 Fiber Cable Lens Inspection and Cleaning.....	58
11.3.1 Lens Inspection Procedure	58
11.3.2 Cleaning the Lens.....	58
12 TROUBLESHOOTING	59
13 TRANSPORTATION AND STORAGE	62
APPENDIX A – LABELS	63
APPENDIX B – TIP GUIDE.....	67
APPENDIX C – ACCESSORIES/SPARE PARTS	68
APPENDIX D – ELECTROMAGNETIC COMPATIBILITY.....	69
APPENDIX E – WIRELESS EQUIPMENT COMPLIANCE STATEMENT.....	73

Introduction

Congratulations on the addition of the Epic Pro diode laser system to your practice!

This User Manual is designed to help you become familiar with the operation and functions of the laser system. Read it carefully before using the laser clinically, follow all safety instructions and cautions, and always have it accessible for use as a reference.

We appreciate your commitment to better care and know your investment in this technology is a sound foundation for the successful growth of your practice.

BIOLASE Team



1 Overview

The Epic Pro diode laser system is a surgical device designed for a wide variety of surgical and oral soft-tissue procedures, and for dental whitening.

Epic Pro utilizes a solid state diode as a semiconductor source for invisible infrared radiation. The energy is delivered to the treatment site via a flexible fiber connected at one end to the laser source and the other end to the Handpiece. Various types of single use, disposable Tips are designed and optimized for different applications. The device is activated by means of a wireless Foot Pedal.

This prescription device is indicated for professional use only by licensed dental practitioners. The use of this device requires proper clinical and technical training. This manual provides instructions for those professionals that have completed the appropriate training.

In Canada, the device must be installed, operated, and maintained in accordance to the guidelines of CAN/CSA-Z386-14.

When used and maintained properly, the Epic Pro will prove a valuable addition to your practice. Please contact BIOLASE Customer Service at **1-800-321-6717** (1-949-273-6691) in the U.S. for any service needs. Outside the U.S., please contact your authorized BIOLASE distributor.

2 Indications for Use

The Epic Pro device with surgical laser operation (Automatic Power Control), used in contact or non-contact mode, is indicated for dental soft-tissue indications including incision, excision, vaporization, ablation, hemostasis, or coagulation of intraoral and extra-oral soft-tissue (including marginal and interdental gingiva and epithelial lining of free gingiva); examples include:

- Frenectomy
- Debridement of diseased epithelial lining
- Frenotomy
- Incisions and draining of abscesses
- Biopsy
- Tissue retraction for impressions
- Operculectomy
- Papillectomy
- Implant recovery/uncovery
- Vestibuloplasty
- Gingivectomy
- Excision of lesions
- Gingivoplasty
- Exposure of unerupted teeth/partially erupted teeth
- Gingival troughing
- Leukoplakia
- Crown lengthening
- Removal of hyperplastic tissues
- Removal of granulation tissue
- Laser-assisted flap surgery
- Sulcular debridement (removal of diseased or inflamed soft-tissue in the periodontal pocket)

The Epic Pro device with surgical laser operation, used in contact or non-contact mode, is intended for use in general surgery for incision/excision, vaporization, ablation and coagulation of soft-tissue.

2 Indications for Use

The Epic Pro device with dental laser operation, used in contact or non-contact mode, is intended for incision, excision, vaporization, ablation, hemostasis, or coagulation of intraoral and extra-oral soft-tissue (including marginal and interdental gingiva and epithelial lining of free gingiva); examples include:

- Frenectomy
- Debridement of diseased epithelial lining
- Frenotomy
- Incisions and draining of abscesses
- Biopsy
- Tissue retraction for impressions
- Operculectomy
- Papillectomy
- Implant recovery/uncovery
- Vestibuloplasty
- Gingivectomy
- Excision of lesions
- Gingivoplasty
- Exposure of unerupted teeth/partially erupted teeth
- Gingival troughing
- Leukoplakia
- Crown lengthening
- Removal of hyperplastic tissues
- Removal of granulation tissue
- Laser-assisted flap surgery
- Hemostasis of donor site
- Pulpotomy
- Treatment of aphthous ulcers
- Pulpotomy as an adjunct to root canal therapy
- Sulcular debridement (removal of diseased or inflamed soft-tissue in the periodontal pocket)
- Light activation of bleaching materials for teeth whitening

3 Contraindications, Warnings, and Precautions

3.1 CONTRAINDICATIONS

All clinical procedures performed with Epic Pro must be subjected to the same clinical judgment and care as with traditional techniques. Patient risk must always be considered and fully understood before clinical treatment. The clinician must completely understand the patient's medical history prior to treatment and exercise caution for general medical conditions which might contraindicate a local procedure; such conditions may include, but are not limited to, allergy to local or topical anesthetics, heart disease, lung disease, bleeding disorders, sleep apnea or an immune system deficiency or any medical conditions or medications that may contraindicate use of certain light/laser type sources associated with this device. Medical clearance from the patient's physician is advisable when doubt exists regarding treatment. Epic Pro treatment may be contraindicated for patients suffering from photodermatosis, photosensitive patients, and patients who are taking photosensitive drugs. Conditions such as pregnancy or pacemakers are not known as contraindications for laser light energy.

3.2 WARNINGS AND PRECAUTIONS

PRESCRIPTION STATEMENT

U.S. Federal Law restricts this device to sale by or on the order of a dentist or dental specialist.

TRAINING

Only licensed professionals who have reviewed and understood this User Manual should use this device. BIOLASE assumes no responsibility for parameters, techniques, methods, or results. Physicians must use their own clinical judgment and professionalism in determining all aspects of treatment, technique, proper power settings, interval, duration, etc.

EYEWEAR

Doctor, patient, assistant and all others inside or entering the operatory must wear appropriate laser protection eyewear for the $940\text{nm} \pm 20\text{ nm}$ wavelength, OD 5 (DIR LB5) or greater whenever the laser is in user. Prior to use, inspect eyewear for pitting and/or cracking. Do not use if damaged.



CAUTION: The specifications for the protective eyewear provided with the Epic Pro laser system are marked on the side of the glasses. **Always check the eyewear specifications marked on the glasses to ensure they offer the required protection for the specific laser wavelength.**

For additional information refer to the instructions for use provided with the glasses.

ANESTHESIA

In soft-tissue cases anesthesia may not be required, but patients should be closely monitored for signs of pain or discomfort at all times. If such signs are present, adjust settings, apply anesthesia, or cease treatment if required.

3 Contraindications, Warnings, and Precautions

TREATMENT, TECHNIQUE, AND SETTINGS

Use your clinical judgment to determine all aspects of treatment including, but not limited to, the laser treatment protocol, technique, power settings, pulse duration and interval settings, mode of operation, as well as the accessories (e.g. tip type) and other procedural requirements. Closely observe and monitor clinical effects and use your judgment to determine the clinical parameters and approach for the treatment; make appropriate power, pulse length, and interval adjustments to compensate for varying tissue composition, density, and thickness. Always start treatment at the lowest power setting for the specific indication and increase as required. BIOLASE assumes no responsibility for parameters, techniques, methods, or results.

ADJACENT STRUCTURES

Epic Pro is designed to remove soft tissues. Therefore, always be aware of adjacent structures and substructures during use. Be extremely careful not to inadvertently penetrate or ablate underlying or adjacent tissues. Do not direct energy toward hard tissue such as tooth or bone. Do not direct energy towards amalgam, gold or other metallic surfaces. Do not direct energy towards cements or other filling materials. Exercise extreme caution when using this device in areas such as pockets, cavities or channels such as third molar sockets, where critical structures (i.e. nerves, vessels) could be damaged. Do not proceed with using the laser if visibility is limited in these areas.

SUCTION

Use high-speed suction as required to maintain a clear field of vision during treatment. Do not use the Epic Pro if you cannot clearly see the treatment site.

PLUME REMOVAL



CAUTION: Laser plume may contain viable tissue particulates.

Special care must be taken to prevent infection from the laser plume generated by vaporization of virally or bacterially infected tissue. Ensure that appropriate protective equipment, including high-speed suction to remove the plume, appropriately filtered masks, and other protective gear is used at all times during the laser procedure.

CLINICAL ENVIRONMENT

Only use this device in clinical environments that observe proper standard aseptic techniques with all oral procedures.

4 Specifications

4.1 GENERAL

- Dimension (W x L x H) 7.25in x 4.5in x 6.5in (18.4cm x 11.4cm x 16.5cm)
- Weight 4lbs (1.8kg)

4.2 ELECTRICAL

- Operating Voltage 100V-240V ~ at 1.2A/0.5A
- Frequency 50/60 Hz
- External Fuses None
- Main Control Main Power Switch
- Remote Interruption Remote Interlock Connector
- Disable Control Emergency Stop Button

4.3 LASER

- Laser Classification IV (4)
- Medium Semi-Conductor Diode
- Wavelength 940 ± 20nm
- Max Power Output 25W
- Power Accuracy ± 20%
- Power Modes Continuous, Pulse Modulation
- Fiber Tips Diameter 300µm, 400µm
- Pulse Duration 10µs-100ms
- Max. Energy Pulse 3.0J
- Pulse Repetition Rate Up to 20kHz (for reference)
- Spot Size
 - Surgical Handpiece 400µm (maximum in contact mode)
 - Whitening Handpice Rectangular 35mm x 8mm = 2cm²
- NOHD (Nominal Ocular Hazard Distance) 4.77 meters
- MPE (Maximum Permissible Exposure) 30W/m²
- Beam Divergence 0.22
- Standard Fiber Cable Length 6 feet (1.8 meters)

4.4 OTHER LIGHT SOURCES

- Aiming Beam Laser Diode, 5mW Max. C.W. @450-680nm, Class 3R

5 Equipment Description

5.1 SYSTEM COMPONENTS

The Epic Pro laser system includes the following:

1. Laser Console
2. Fiber Management Module
3. Fiber Optic Cable
4. Surgical Handpiece (2)
5. Assorted Surgical Tips (non-initiated and pre-initiated)
6. Wireless Foot Pedal
7. Protective Eyewear (3)
8. Power Supply/Adapter
9. Power Cord (1-US, 1-Int'l)
10. Disposable Screen Protectors (30)
11. Remote Interlock Connector
12. AAA Batteries (2-pack)
13. Welcome Kit (Includes User Manual and Laser Warning Sign)



WARNING: No modification of this equipment is allowed.

5.2 GENERAL

The Epic Pro laser system consists of three components:

1. Console and fiber management module
2. Reusable fiber delivery system (Fiber Optic Cable, reusable surgical Handpiece, fiber Tips)
3. Wireless Foot Pedal

4 Equipment Description

CONSOLE

The console, supported by a snap-on table base, is portable, contains the diode laser and all the elements which power the laser. A touch screen Graphical User Interface (GUI) allows the user to navigate from screen to screen, select procedures, enter and/or change settings, view system status, etc. (Figure 4.1)

FIBER MANAGEMENT MODULE

This module is a separate component that clips onto the console. It provides a storage channel for the fiber and a holder for the Handpiece (Figure 4.1).

FIBER OPTIC CABLE

The Fiber Optic Cable transmits the laser radiation from the laser console through the Handpiece and fiber Tips to the target tissue.

SURGICAL HANDPIECE

Part of the delivery system, the surgical Handpiece is re-useable and detachable from the fiber. It is the conduit through which the laser energy flows from the Fiber Optic Cable to the Tip.

FIBER TIPS

Fiber Tips deliver the energy generated by the laser and transmitted through the Fiber Optic Cable to the treatment site.



Figure 4.1

5 Equipment Description

WIRELESS FOOT PEDAL

Epic Pro is activated by a Foot Pedal designed to work using wireless technology. It is powered by two (2) AAA batteries (Refer to section 11 for instructions on how to install/replace the Foot Pedal batteries).

The Epic Pro laser will only emit laser energy when the Foot Pedal is pressed while the laser is in **Ready** mode.

The Foot Pedal and laser are shipped from the factory already paired.

The Foot Pedal is protected by a metal cover. To access, press down on the cover (Figure 4.2).

Three separate LED indicator lights are displayed on the rear panel of the Foot Pedal.

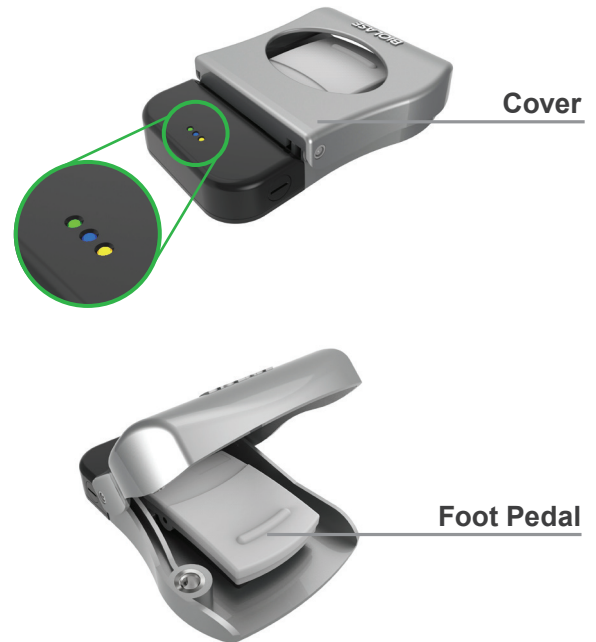

Figure 4.2

LED Indicator	Status	
Amber	Blinking or Solid	A critical error or short has occurred; the relevant error message will appear on the tablet screen.
Blue	Solid	The Foot Pedal is connecting to the laser, or has successfully paired with the laser.
Green	Blinking	The Foot Pedal batteries are low; replace the batteries.
Green	Solid	ON: the Foot Pedal is pressed while paired to the laser; OFF: the footswitch is not pressed, or the system is in Sleep mode, or the batteries are dead.

6 Safety with the Epic Pro

Failure to comply with precautions and warnings described in this user manual may lead to exposure to dangerous optical radiation sources. Please comply with all safety instructions and warnings.



WARNING: No modification of this equipment is allowed.

6.1 SAFETY INSTRUCTIONS



LASER WARNING: Emits invisible and/or visible laser radiation. Avoid eye or skin exposure to direct or scattered radiation. Do not use the Laser System in any manner other than as described in this User Manual; do not use the Laser System if you suspect it is not functioning properly; do not use procedures other than those specified herein as it may result in hazardous radiation exposure.

Follow these safety instructions before and during treatments:

- When the laser is in use, **all operatory entrances must be marked** with an appropriate warning sign (included)
- **Do not** operate in the presence of explosive or flammable materials. Flammable anesthetics or oxidizing gases such as nitrous oxide (N₂O) and oxygen should be avoided. Solvents of adhesives and flammable solutions used for cleaning and disinfecting should be allowed to evaporate before the laser is used. Attention should also be drawn to the danger of ignition of endogenous gases
- **All persons present in the operatory must wear laser protective eyewear.** Always ensure that the laser protective eyewear is appropriate for the laser wavelength; refer to the markings on the eyewear itself for the specifications of the protection provided.
- **Do not** look directly into the beam or at specular reflections
- **Never** direct or point the beam at a person's eyes
- **Always** place the system into **Standby** mode before exchanging the fiber delivery system, Handpieces or disposable Tips
- **Always** ensure the proper laser parameters are set before the Epic Pro is used in a clinical procedure
- Before leaving the unit unattended, return to the Home screen so the device cannot accidentally emit laser energy. The laser can also be turned off at the power switch
- **Do not** use the Epic Pro if the Fiber Optic Cable is damaged or broken

6 Safety with the Epic Pro



LASER WARNING: Do not open the console housing at any time. Danger from optical radiation may exist.



LASER WARNING: Do not aim the laser at metallic or reflective surfaces, such as surgical instruments or dental mirrors. If aimed directly at these surfaces the laser beam will be reflected and create a potential hazard.



CAUTION: This laser system has been designed and tested to meet the requirements of electromagnetic, electrostatic, and radio frequency interference standards. However, the possibility of electromagnetic or other interference may still exist. Relocating the device may help to eliminate the interference.



CAUTION: High temperatures produced in the normal use of this laser equipment may ignite some materials (e.g., cotton wool when saturated with oxygen); solvents or adhesive and flammable solutions used for cleaning and disinfecting should be allowed to evaporate before the laser is activated.



CAUTION: Be aware that the metal / cannula on the Tips may become hot during use. Avoid touching any tissue with the cannula.

6.2 SAFETY CLASSIFICATION

The following safety classifications are applicable to the device:

- Laser Radiation – Class 4
- Aiming Beam – Class 3R
- Type of protection against electrical shock – Class 2
- Degree of protection against electrical shock – Type BF Class 1
- Not protected against water ingress – Ordinary Equipment
- Not suitable for use in presence of flammable anesthetic mixture
- Operation Mode – Continuous Wave and Pulse Modulation
- Wireless Foot Pedal – IPX6

6 Safety with the Epic Pro

6.3 SAFETY FEATURES

SYSTEM MONITOR

The system monitors the emergency stop switch, remote key, wireless Foot Pedal connection, and output power. An error in any one of these will stop the system. The text display will indicate the type of error. Operation will not resume until the error is cleared.

POWER SWITCH

The laser console can be switched ON (I) or OFF (O) using the Power Switch on the side of the console (Figure 6.1).

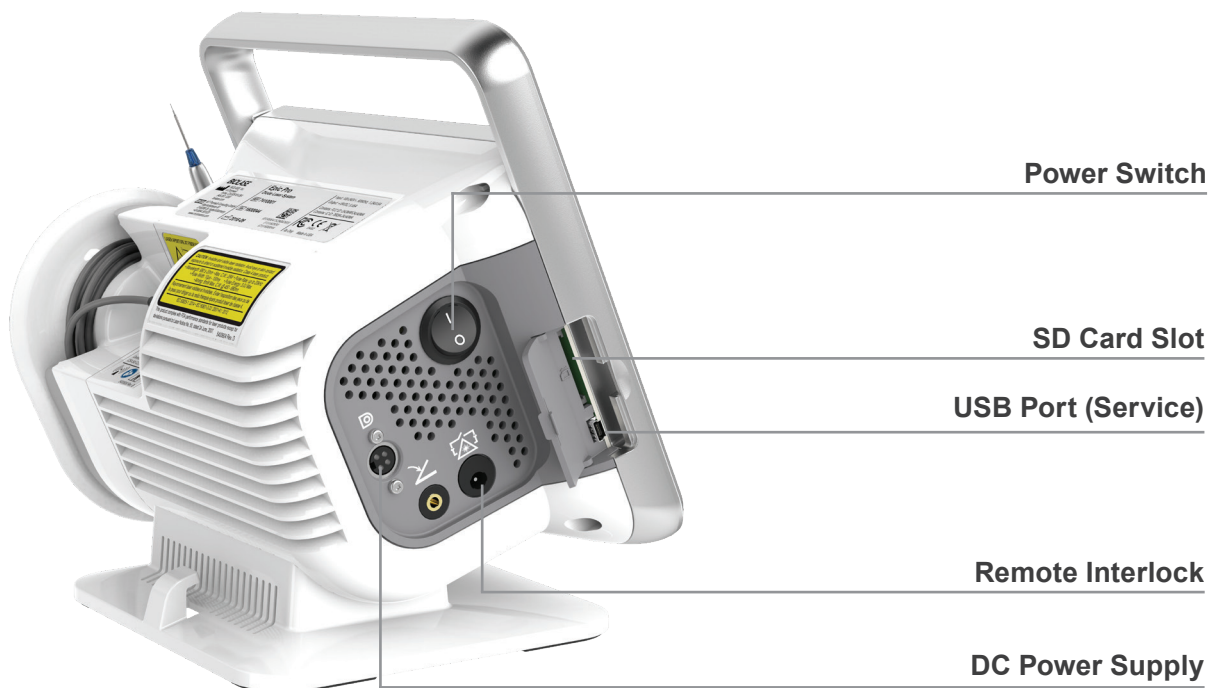

Figure 6.1



Figure 6.2



CAUTION: Use only the power supply module and power cord supplied with the Epic Pro laser system.

6 Safety with the Epic Pro

ACCESS KEY CODE

The Access Key Code (**888**) prevents unauthorized use of the system. It is activated every time the system is turned ON with the Power Switch.

WIRELESS FOOT PEDAL

The Epic Pro will not emit laser energy until the user presses down on the Foot Pedal while the laser is in **Ready** mode. The Foot Pedal is designed to work using wireless technology.

REMOTE INTERLOCK

The Epic Pro console is equipped with a remote interlock feature that links a door switch (optional) with the Epic Pro console and will prevent the laser from firing when the sensor is triggered. To utilize this safety feature, wire the remote interlock plug to a multi-conductor wire and insert it into the opening at the side of the laser console (Figure 6.3). Attach the other end of the wire to a door switch/sensor; if the closed door is opened, the connection to the switch is deactivated, immediately stopping the laser from firing. To override this feature, don't connect the plug to a door switch.

The remote interlock plug must be inserted into the console in order for the laser to operate, whether or not the remote interlock function is used.

EMERGENCY STOP

Press the red Emergency Laser Stop button located on the bottom left of the front panel to instantly turn off the laser console (Figure 6.4). The laser will immediately stop, the screen will go dark, and the system will need to be completely powered OFF and then rebooted to resume operation.



Figure 6.3



Figure 6.4

7 Installation and Set-Up

7.1 FACILITY REQUIREMENTS

- Electrical Supply (100-240V ~): 1.2A/0.5A, 50/60Hz
- Environmental Requirements: Temperature: 15-30 °C
Humidity: 20-80%, Non-condensing



CAUTION: Do not position this equipment so that it is difficult to pull the plug from the power source. To avoid the risk of electric shock, this equipment must only be connected to a supply mains with protective earth.



CAUTION: Do not stack this device with other equipment, as it could affect proper operation. Always monitor this and any adjacent equipment to ensure they are operating normally.

7.2 SYSTEM SETUP

The Epic Pro is designed to be transportable between operatories using the built-in handle. Prior to use, the laser must be properly set up as described in this user manual to ensure safe and efficient functionality.

- Attach the base to the console by aligning the grooves on the bottom of the console to the grooves on the base and then sliding the console from front to back until it clicks into place
- Press the lever of the fiber management module and push it onto the right side of the console until it clicks into place (Figure 7.1)



Figure 7.1

7 Installation and Set-Up

- Place the unit on a flat surface in a clean, dry, and well-ventilated area
- Verify the power switch is in the OFF (O) position
- Connect the power supply/adaptor to the laser console by orienting the power supply plug as indicated by the symbol on the connector panel and inserting it fully into the console power jack until snug (Figure 7.2). Plug the power cord into the power supply and insert the distal end of the cord into a wall outlet. Make sure the remote interlock plug is in place.



Figure 7.2



CAUTION: Never touch the exposed pins and the patient simultaneously whenever the fiber management module is not attached to the console, but the laser is ON (I), to avoid electric shock to the patient.

7.3 SURGICAL DELIVERY SYSTEM



CAUTION: The Fiber Optic Cable is detachable from the console; it cannot be autoclaved but **must always be disinfected between patients** by following the procedure outlined in section 10.3.

- Verify the power switch is in the OFF (O) position
- Remove the protective cap on the end of the fiber connector (the cap is reusable and required when storing the fiber)
- Attach the Fiber Optic Cable to the console by aligning the center of the fiber SMA connector with the center of the port at the rear of the console, gently inserting the connector into the port until snug, and turning it clockwise until secure (Figure 7.3)
- To disconnect the Fiber Optic Cable from the console, turn the SMA connector counterclockwise; when loose, pull gently from the connector port

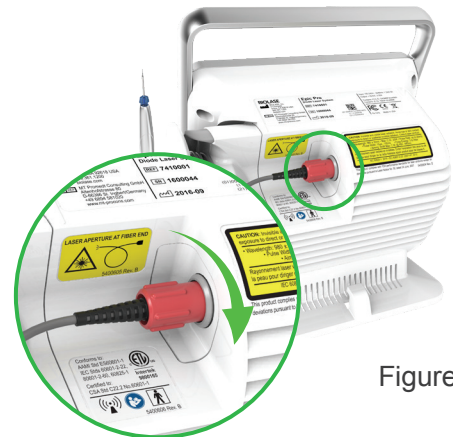

Figure 7.3



CAUTION: Do not connect or disconnect the fiber while the laser is turned ON. **Only connect or disconnect the Fiber Optic Cable when the laser is turned OFF.**



CAUTION: Never bend the Fiber Optic Cable at a sharp angle, as it can break the internal optical fiber.



CAUTION: Avoid direct contact with the proximal end of the Fiber Optic Cable SMA connector. Contamination of the connector may result in laser damage.

7 Installation and Set-Up

7.4 SURGICAL HANDPIECE ASSEMBLY



CAUTION: Handpieces are not sterile when sold and must be sterilized prior to initial use, and cleaned and sterilized between patients to avoid cross-contamination between patients. Refer to Section 10 for complete instructions on cleaning and sterilization.

- Remove the protective red cap from the distal end of the fiber shaft (do not discard)
- Connect the Handpiece to the Fiber Optic Cable assembly by pushing the Handpiece onto the fiber shaft until it clicks on and is secured (Figures 7.4, 7.5)

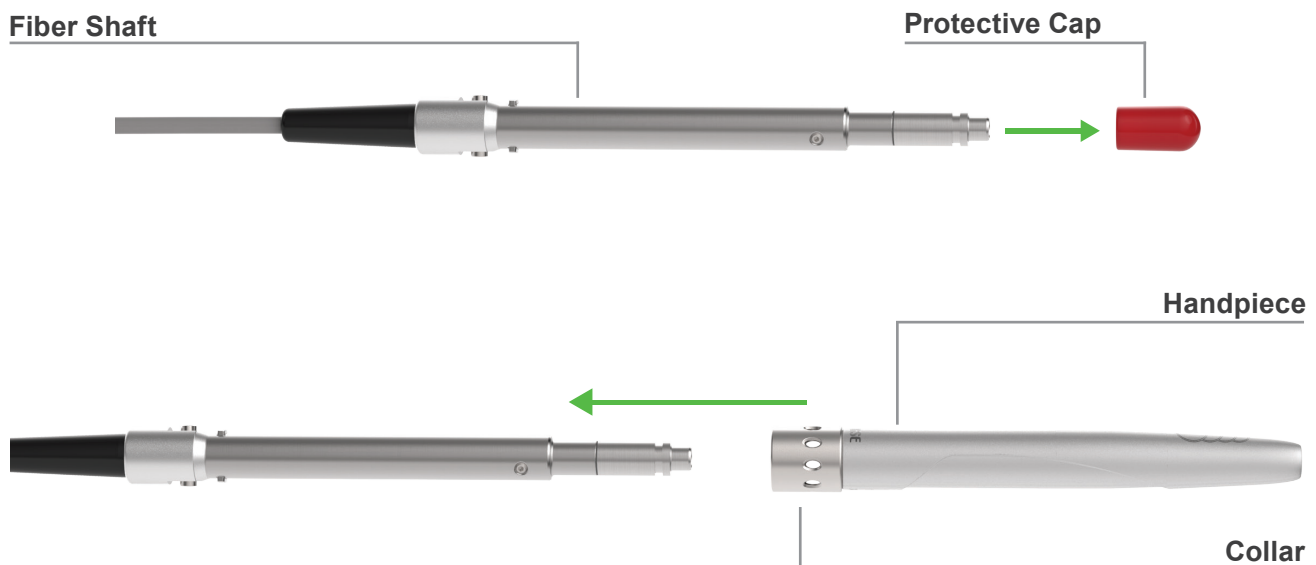

Figure 7.4: Connecting the Handpiece to the Fiber Optic Cable assembly



Figure 7.5: Surgical Handpiece Assembly fully assembled

7 Installation and Set-Up

Disconnect the Handpiece from the Fiber Optic Cable assembly (Figure 7.6):

1. Take the Handpiece body in one hand and the shaft in the other,
2. Push the two buttons on the fiber shaft,
3. Gently pull the Handpiece by the collar to separate it from the fiber shaft.

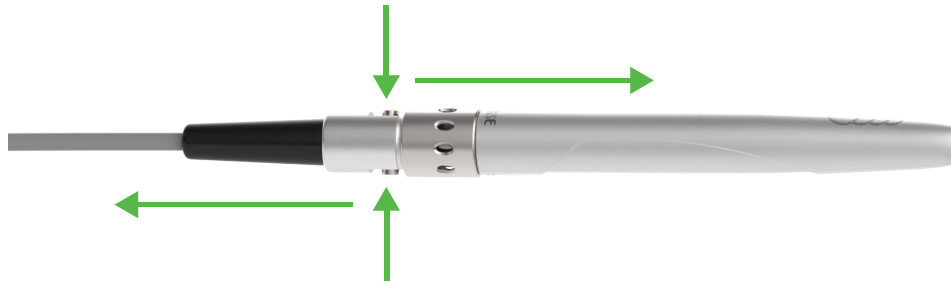

Figure 7.6: Disconnecting the Handpiece from the Fiber Optic Cable

7.5 SINGLE-USE TIPS

Fiber Tips are single-use accessories available in 300 μ m and 400 μ m core diameters and in different lengths; Tips are available non-initiated, for procedures that do not involve cutting tissue, such as hemostasis, or pre-initiated, for all ablative procedures. The choice of which Tip to use is based on the type of procedure/treatment mode. Refer to Section 9 for a details on procedures and related presets and recommended Tips.



CAUTION: Tips are for one-time use only to avoid cross-contamination and are designed to withstand only a single sterilization cycle. Always visually inspect the Tip prior to use to make sure it is free of debris or damage



CAUTION: Be aware that the metal cannula on the Tips may become hot during use. Avoid touching any tissue with the cannula.

To connect the Tip, **first connect the Handpiece to the Fiber Optic Cable**, then insert the Tip firmly into the distal end of the Handpiece as far as it will go, and tighten by turning clockwise until snug (Figure 7.7). Bend the metal cannula according to the specific procedure requirements (Figure 7.10).

Remove the Tip by twisting it counterclockwise (Figure 7.8).

7 Installation and Set-Up



CAUTION: To deliver proper laser operation, do not install Tips when the Handpiece is not connected to the Fiber Optic Cable.



Figure 7.7: Insert the fiber Tip into the Handpiece (**only when the Handpiece is connected to the Fiber Optic Cable**) and twist clockwise until snug



Figure 7.8: Remove the fiber Tip by twisting the Tip counterclockwise

Correct



Incorrect



Figure 7.9: Installing the Tip

Correct



Incorrect

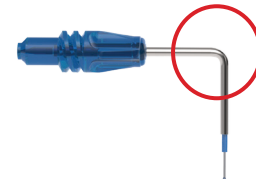

Figure 7.10: Bending the Tip cannula

7 Installation and Set-Up

7.6 WHITENING HANDPIECE (OPTIONAL ACCESSORY)

The Whitening Handpiece (Figure 7.11) is a reusable accessory intended for light activation of bleaching materials in tooth whitening procedures. It is equipped with disposable non-sterile protective shields for single patient use (Figure 7.12) and requires disinfection before and after each patient treatment. **This Handpiece cannot be sterilized in the autoclave.** Doing so will damage its internal optics. For instructions on how to disinfect the Whitening Handpiece, refer to Section 10.



Figure 7.11

The disposable shield fits over the head of the Handpiece and must be discarded after one-time use to avoid cross-contamination between patients. Always wipe with alcohol prior to use.

To connect the Handpiece to the Fiber Optic Cable, push it onto the fiber shaft until it clicks on and is secured.

To disconnect the Handpiece from the Fiber Optic Cable:

- Take the Handpiece body in one hand and the shaft in another
- Press both buttons at the base of the fiber shaft
- Gently pull the Handpiece from the collar without twisting to separate

7.6.1 WHITENING GEL

The Whitening Handpiece is designed to work with LaserWhite™ 20 Whitening Gel to achieve teeth whitening. This item is sold separately as a kit in packs of five (5). Detailed step-by-step instructions, contraindications, precautions, and warnings for teeth whitening are provided with the LaserWhite 20 Whitening Gel Kit. Please read the instructions carefully before proceeding with the procedure.



Figure 7.12

7 Installation and Set-Up

7.7 PAIRING THE FOOTSWITCH AND LASER

Epic Pro ships with the laser and Wireless Foot Pedal already paired. However, if the wireless connection should fail at any time, pairing will need to be re-established by taking the following steps:

Make sure two (2) AAA fully charged batteries are installed in the Foot Pedal.

Go to the System Settings Menu by pressing the Settings icon at the bottom right of the screen. Select “Foot Pedal” and follow the instructions displayed on the next series of screens.

1. Place the Foot Pedal on a flat surface (Figure 7.13). Make sure to wake-up the Foot Pedal if it has gone to sleep.
2. Use a coin or a flat-head screw driver to loosen the battery compartment cover on the side of the Foot Pedal without completely removing it, until the blue LED turns off. If the light stays on, loosen the compartment cover further, or remove it altogether. Pairing will not be possible unless the LED is off (Figure 7.14).
3. Release the Foot Pedal cover to expose the Foot Pedal pedal; press down on the Foot Pedal pedal and hold.
4. While the Foot Pedal pedal is pressed, screw the battery compartment cover back in place; continue pressing the Foot Pedal pedal for an additional 5 seconds (Figure 7.15); both the blue and green LEDs will turn on indicating the Foot Pedal is ready to pair. Once the Foot Pedal Assembly is ready to pair, you may release the Foot Pedal pedal (Figure 7.16).

If pairing is successful, a “Pair Success” message appears on the screen (only the blue LED will light up on the Foot Pedal); press “Return to Home” to begin using the laser.

If the pairing operation times out, the screen will display the message “Pairing Timed Out” and offer the option to “Try Again.”

If replacing an existing Foot Pedal, first insert two (2) new AAA batteries in the battery compartment, then follow the pairing steps noted above.



Figure 7.13



Figure 7.14



Figure 7.15



Figure 7.16

8 Operating Instructions

8.1 EPIC PRO INTERACTIVE DISPLAY

The Epic Pro interactive display allows for touch screen operation. All functions are activated by gently touching the appropriate button on the display. Apply the disposable screen protector provided before use to protect the screen from water and debris.

8.2 ICONS - DEFINITIONS

The Epic Pro Graphic User Interface (GUI) is the main part of the system control. It communicates with the user through the interactive touchscreen display and is designed to provide easy and intuitive interaction with the laser system while performing clinical procedures. Buttons on each screen allow easy navigation of the GUI.













 Favorites	 Home
 Settings	 Back Button (Return to Previous Screen)
 Advanced Mode Indicator	 Signal Strength Indicator (Wireless FS)
 Settings modified and saved	 Settings modified but not saved
 FS Battery Strength Indicator	 Decrease setting/Increase setting
 System Information	 Service

Figure 8.1

8 Operating Instructions

8.3 SYSTEM START-UP AND FUNCTIONS

Turn the power switch at the side of the console to the ON (I) position. The system will boot up and display two screens in quick succession – the first displaying the “BIOLASE” logo followed by one showing the Epic Pro name; after 3 seconds, the system will display the “Welcome” screen.

8.3.1 LOGIN

Enter the three digit default access code (**888**) using the keypad on the touchscreen. If the incorrect code is keyed, an “**X**” appears in the window; wait 3 seconds for the “**X**” to clear, then re-enter the correct code (Figure 8.3).

After logging in, the Epic Pro will display the Home Screen (Figure 8.4).

While in the Login Screen, the Epic Pro cannot emit laser energy.



CAUTION: Always check the aiming beam before using the laser; the shape of the beam on a surface should be symmetrical. This indicates that the delivery system (Fiber Optic Cable, Handpiece) is working properly. This check should be performed with a non-initiated Tip only.

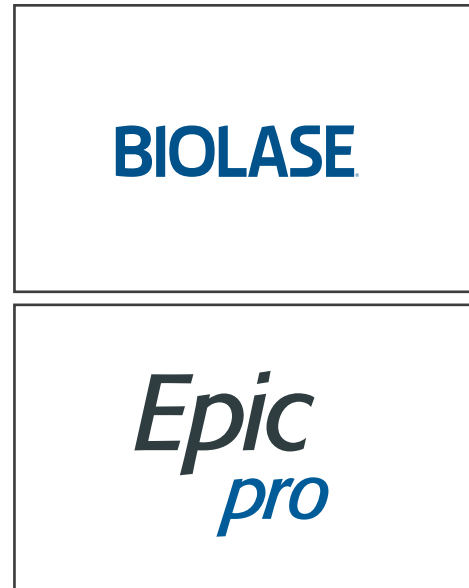

Figure 8.2

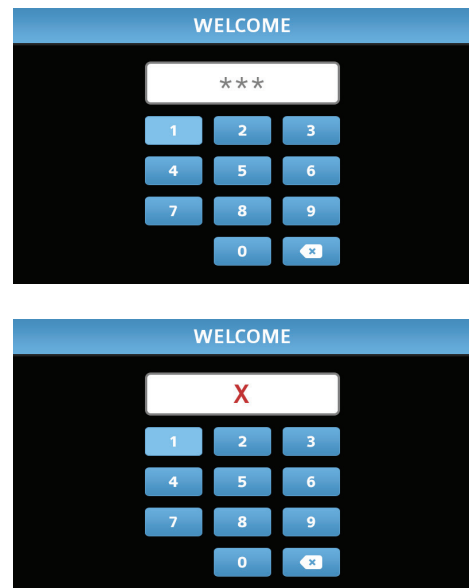

Figure 8.3

8 Operating Instructions

8.3.2 HOME SCREEN

The HOME screen offers the user four operational options (Figure 8.4):

- 1. Quick Start:** accesses the main treatment screen; select the treatment parameters and start treatment immediately.
- 2. Procedures:** displays the Procedures menu; select from a series of factory pre-programmed dental treatments and settings.
- 3. Favorites:** presents a list of the user's favorite procedures/settings; select the chosen procedure/settings and begin treatment.
- 4. Settings:** allows modification of user options and settings.



Figure 8.4

8.3.3 BASIC AND ADVANCED

The Epic Pro laser system offers two levels of operation, **Basic and Advanced**; usage is based on specific procedure requirements and the user's level of training and experience with the laser system.

- **Basic:** Only some of the pre-set parameters for any given procedure may be modified by the user
- **Advanced:** Allows the user to modify all the pre-set values for a procedure, even from a pre-set procedure screen

The user may switch between levels by pressing the Advanced mode Indicator on the bottom right of any procedure screen, or through the Settings menu.

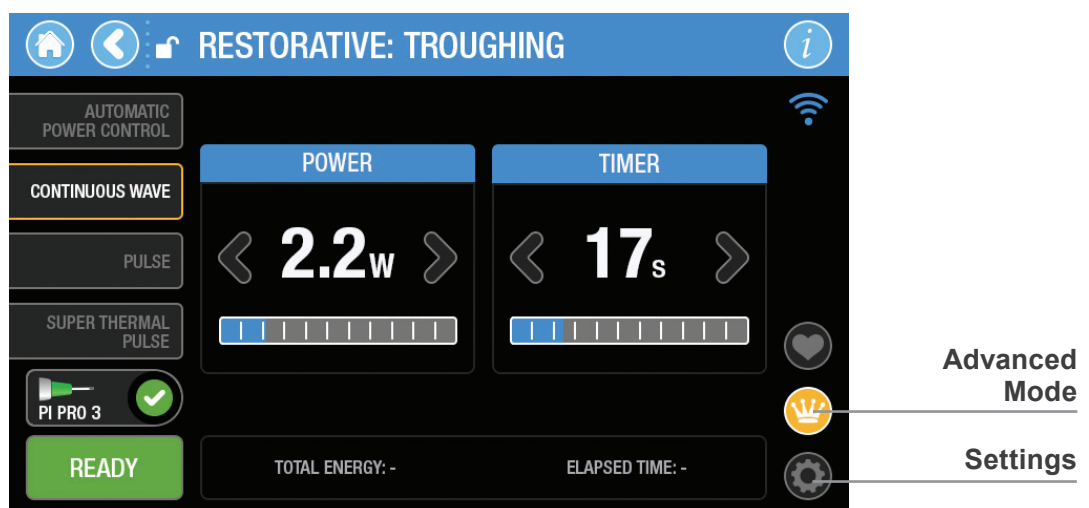

Figure 8.5

8 Operating Instructions

8.3.4 TREATMENT MODES OF OPERATION

The Epic Pro soft-tissue laser is a versatile system that can be used for a variety of surgical and dental soft-tissue procedures. It offers four treatment modes of operation:

- Continuous Wave (CW) Mode (Figure 8.6)
- Automatic Power Control (APC™) (Figure 8.7).
- Pulse Mode (Figure 8.8)
- Super Thermal Pulse (STP™) (Figure 8.9)

While on the main operating screen, the user has the option to toggle between treatment modes of operation, i.e., APC, CW, Pulse and STP modes. Once a selection is made, the screen will display the treatment parameter adjustment controls for the corresponding treatment mode.



NOTE: Whenever the mode is changed from the preset for a procedure, the banner at the top of the screen will change from the procedure name to "Quick Start."

8.3.5 CONTINUOUS WAVE (CW) MODE:

CW treatment mode allows the user to adjust the power and the total time of firing, which can be set to OFF to enable continuous firing with no time limit (Figure 8.6).

When CW is selected while in Basic user mode, the Epic Pro delivers continuous laser power output. This can be increased or decreased incrementally by using the corresponding arrows, or by using the slider at the bottom of the power window. The output power is adjustable from 0.1 to 25W.

The timer, or the length of time the laser will fire continuously without stopping, can either be turned off, or adjusted in increments up to 99 seconds.

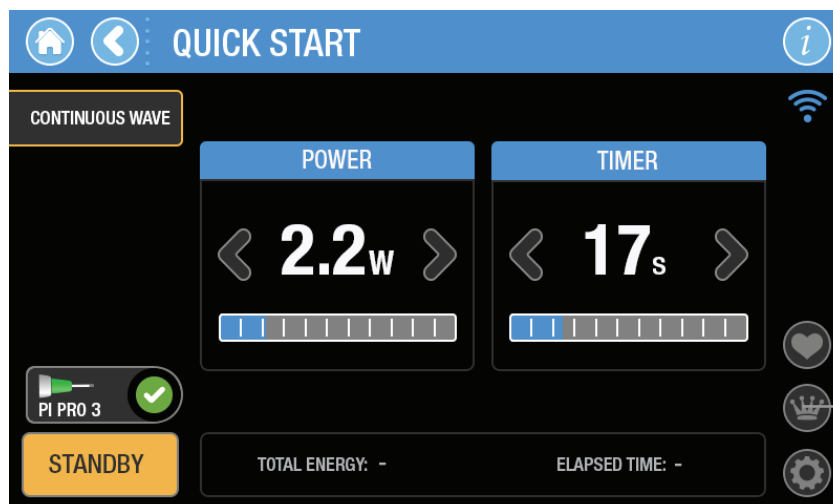

Figure 8.6

8 Operating Instructions

8.3.6 AUTOMATIC POWER CONTROL (APC):

Epic Pro has a treatment mode of operation called Automatic Power Control (APC) in which the laser, in continuous wave mode, converts light energy to thermal power at the tip (Figure 8.7). The cutting effect in contact mode with a pre-initiated Tip is achieved not by the direct action of laser power, but rather by the thermo-mechanical action of a "hot tip." Therefore, Tip temperature is a very important parameter and is adjusted automatically to maintain a uniform temperature, resulting in constant and reliable cutting, independent of speed of movement, tissue type, etc.

In the Advanced level of operation, the peak "not to exceed" upper power limit is adjustable from 3W to 25W. Thermal Level is adjusted automatically when Power Limit is modified within these parameters.

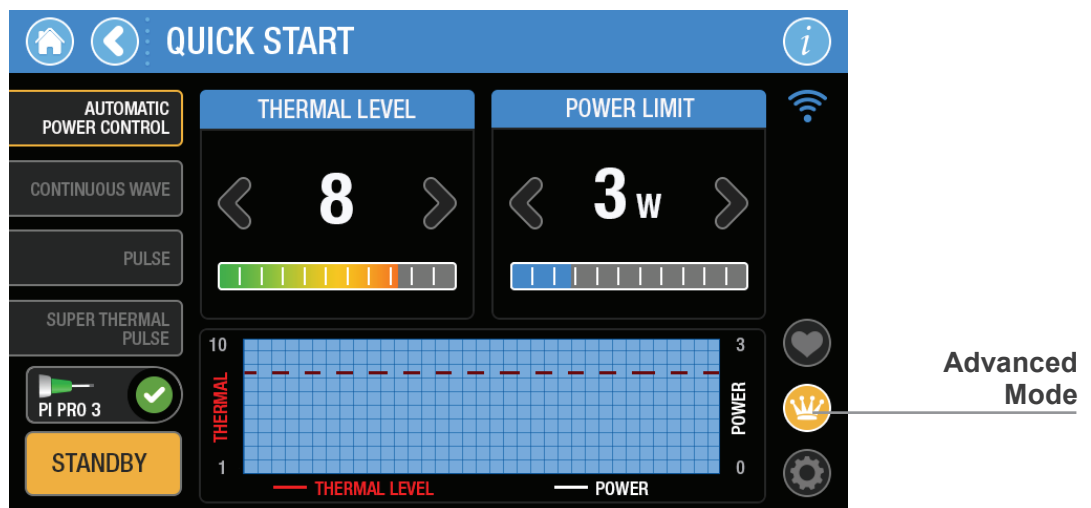

Figure 8.7



CAUTION: APC procedures utilize only pre-initiated tips. **Do not operate the Epic Pro in APC mode with a non-initiated Tip;** the system will not be able to reach the target temperature and will temporarily operate at "Not to Exceed" power, which is much higher than the power required for treatment, before displaying an error message.



CAUTION: The pulse width, peak and average power, and timer duration parameters are not adjustable in the APC operating treatment mode.

8 Operating Instructions

8.3.7 PULSE MODE:

When the Pulse operating treatment mode is selected, Epic Pro delivers repetitive pulses. The peak laser power output can be increased or decreased by moving the power slider right or left. The peak output power is adjustable from 3W up to 150W, depending on the Pulse duration selected (Figure 8.8).

In Pulse mode, pulse width (duration), peak power, average power, and the timer, or the length of time the laser will fire continuously without stopping, are all adjustable.

For each pulse duration (10 μ s – 100ms), there is a corresponding set of peak powers, and for each peak power there is a corresponding average power setting.

When pulse width is adjusted, the corresponding default (minimum) peak power and (maximum) average power are automatically selected and displayed by the system software.

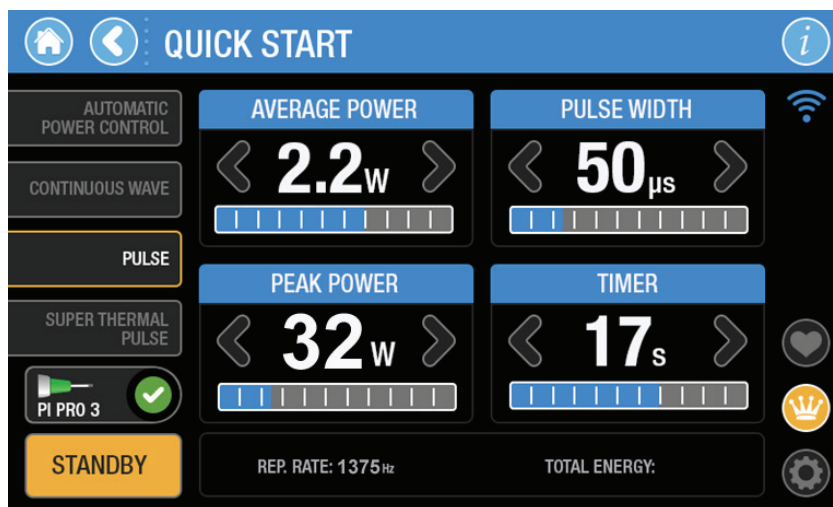

Figure 8.8

8 Operating Instructions

8.3.8 SUPER THERMAL PULSE:

In Super Thermal Pulse (STP) treatment mode, the device converts pulsed laser energy into pulses of thermal power at the Tip, resulting in deeper penetration, more precise cutting, and less trauma to tissue. These power bursts are emitted at a preset pulse width and repetition rate, while maintaining a precise thermal level range at the tip. If the measured Tip temperature is higher than the desired thermal level, the peak power of the laser pulses will be decreased to bring it down; if the measured Tip temperature is lower than desired, the peak power will be increased accordingly. In this way, dynamic control of the peak power ensures the stable temperature range of the Tip and, consequently, consistent thermal effect on the target tissue.

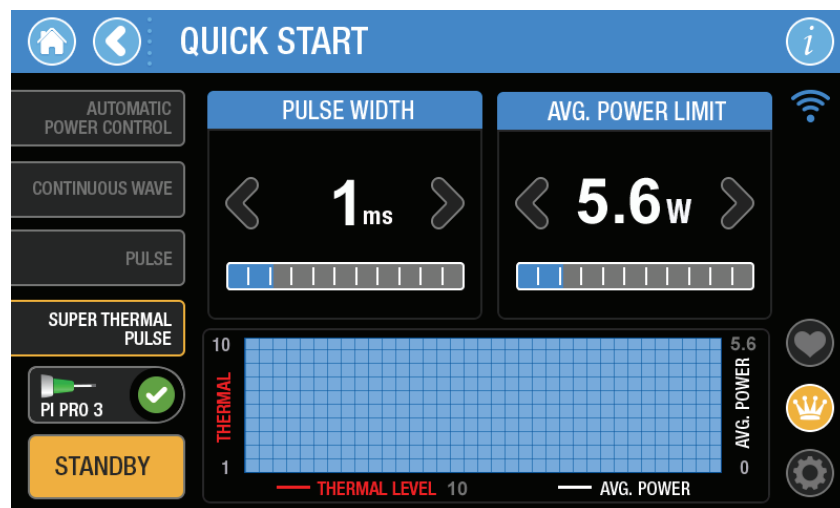

Figure 8.9



CAUTION: STP procedures utilize only pre-initiated Tips. **Do not operate the Epic Pro in STP mode with a non-initiated Tip;** the system will not be able to reach the target temperature and will temporarily operate at “Not to Exceed” power, which is much higher than the power required for treatment, before displaying an error message.

8 Operating Instructions

8.3.9 QUICK START

Selecting Quick Start on the Home screen displays the main operating screen, with APC as the default mode of operation (Figure 8.10). Quick Start allows the user to adjust treatment parameters, select the treatment mode of operation (CW, APC, Pulse, or STP), choose a Tip suitable for the procedure, save custom treatment settings, and, ultimately, fire the laser using the displayed parameters. This screen also offers the user the option to view system settings or procedure info, return to the previous screen, or return to the Home screen. A graphical indicator displays the status of the wireless Foot Pedal connection, while the laser defaults to **Standby** mode.

The main operating screen allows the user to toggle between APC, CW, Pulse, and STP modes, as needed. Once a selection is made, the screen will display the treatment parameter adjustment controls for the corresponding mode of operation for treatment.

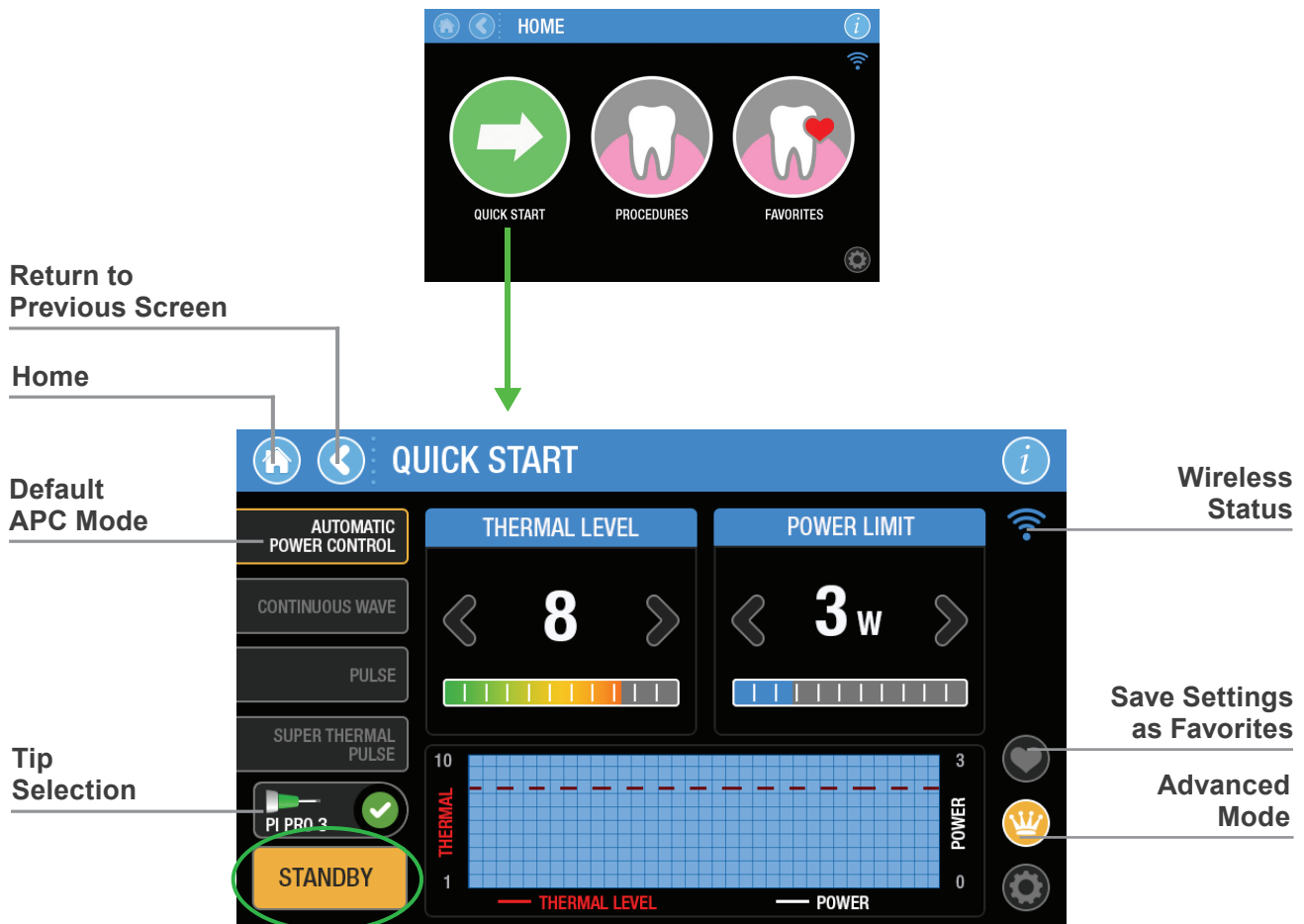

Figure 8.10

8 Operating Instructions

8.3.10 TIP SELECTION

From the main treatment screen, the user has the option of choosing a treatment Tip by pressing the “Select Tip” button; the screen will display a selection of non-initiated and initiated Tips (Figure 8.11).

After Tip selection is completed, the system returns to the main operating screen which will now display the Tip chosen (Figure 8.12)

If an attempt is made to fire the laser without first having selected a Tip, a message stating “Please Select Tip” will appear on the screen and the laser will not fire (Figure 8.13). Press the Select Tip button and choose a Tip as described above, then press on the Foot Pedal to activate the laser.

In the Advanced level of operation, if a pre-initiated Tip is selected in APC or STP modes, the system software returns to the main operating screen and displays a graph that plots the set Tip temperature and real-time laser power during emission.

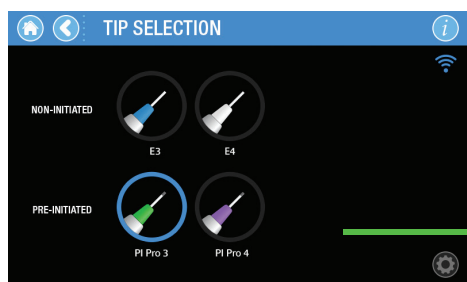

Figure 8.11

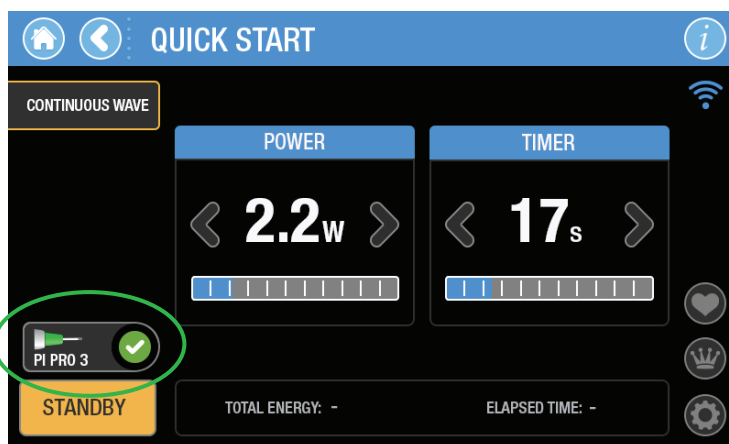

Figure 8.12

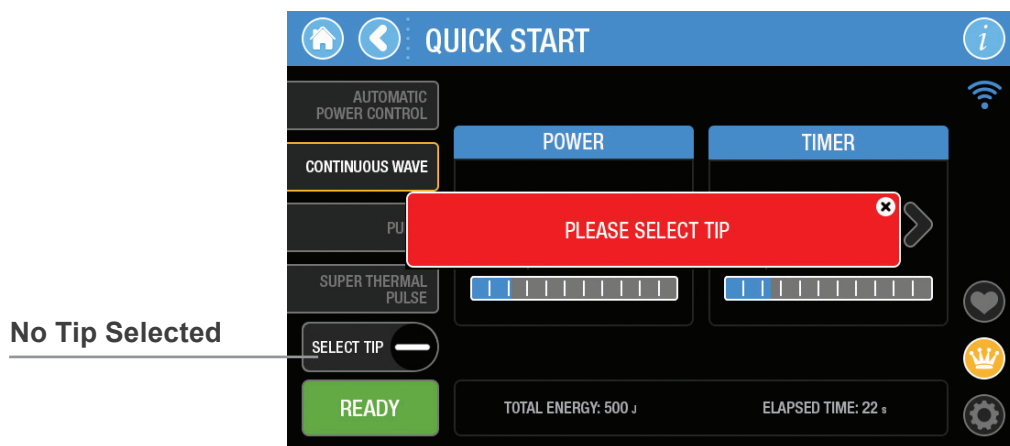

Figure 8.13

8 Operating Instructions

The set Tip temperature and set power limit are displayed on the graph (Figure 8.14). While the laser is emitting laser energy, the program will plot the Tip temperature feedback and real-time power value to achieve the set Tip temperature.

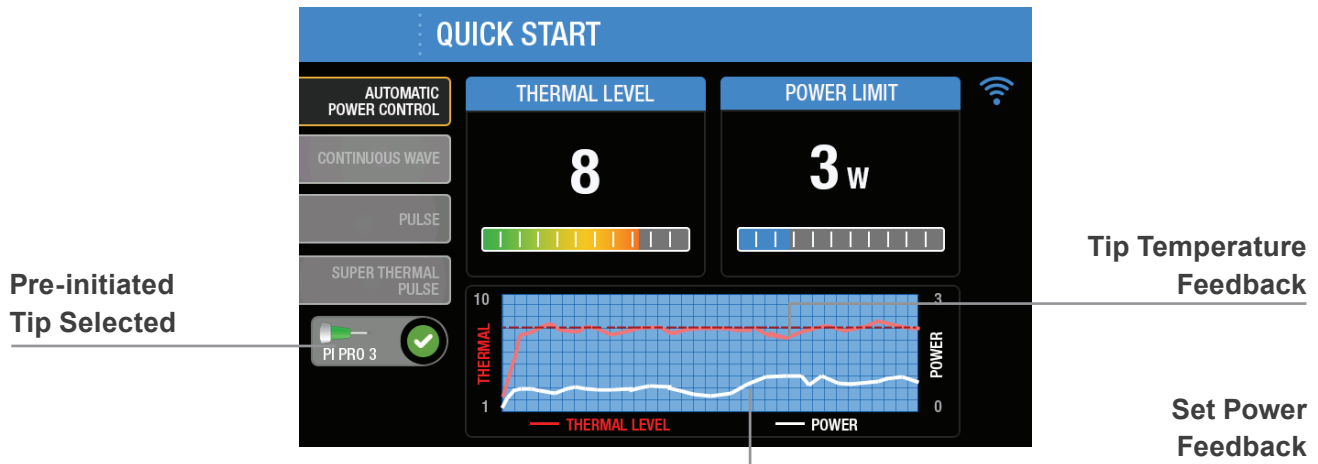

Figure 8.14



CAUTION: Laser power output above the level shown on the touch screen may cause unwanted tissue damage. The optical power output and pulse width must remain within +/- 20% of the selected values while the laser is emitting energy.

8.3.11 TIP WARNING

In APC and STP modes, if a pre-initiated Tip inserted into the Handpiece is not properly initiated, the Tip's initiation has degraded after use, or a non-initiated Tip is inserted, a message will appear on the screen when attempting to fire the laser instructing the user to replace the Tip (Figure 8.15).

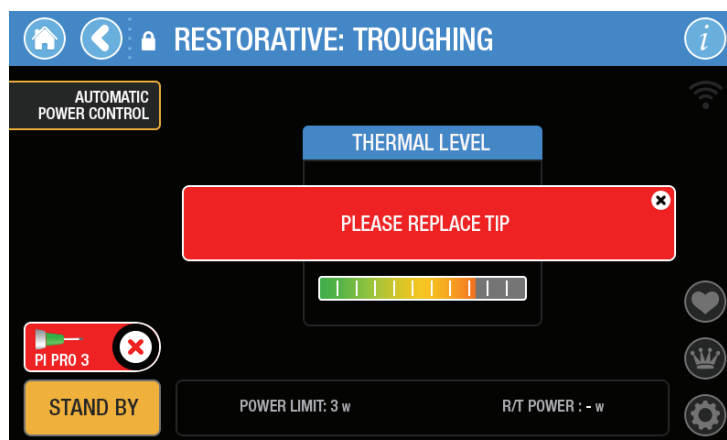

Figure 8.15

8 Operating Instructions

8.3.12 PROCEDURE SELECTION

When Procedures is selected at the Home screen, seven treatment categories are displayed; the user is able to select any one of these to access a specific pre-set procedure (Figure 8.16). However, settings may be adjusted by the user, as needed, on the Main operation screen.

The recommended settings for each indication are preprogrammed at the factory and cannot be deleted. However, they may be adjusted by the user, as needed, on the Main operating screen.

Once a pre-set procedure is chosen, the screen will display the treatment parameters, corresponding mode (APC, CW, Pulse, or STP), and Tip selection established for treatment (Figure 8.17).

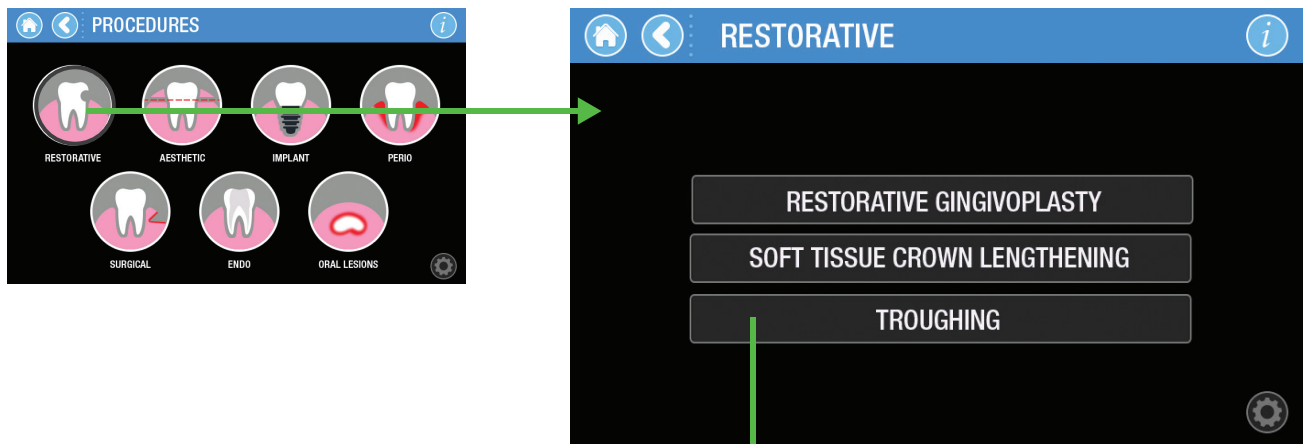

Figure 8.16

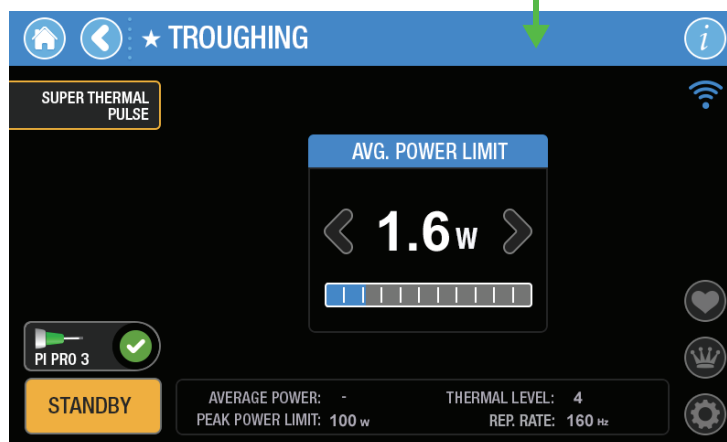

Figure 8.17

8 Operating Instructions

8.3.13 CREATING A FAVORITES PROCEDURE

Any changes to the pre-programmed settings of a clinical procedure can be saved to Favorites by pressing the heart button on the right side of the main operating screen (Figure 8.18):

- A full keyboard and text input field are displayed; the input field is limited to 30 characters, and may be all alpha, all numeric, or a combination of the two. Type in a unique name for the procedure, or leave as the default name set by the system
- Press Save. The settings are now stored in Favorites for use when needed. The program returns to the main treatment screen with the new saved Favorite name displayed on the banner and the Favorites button is highlighted (Figure 8.19)
- The customized procedure is now saved and can be accessed at any time from the Favorites screen

Select Save Favorite Button

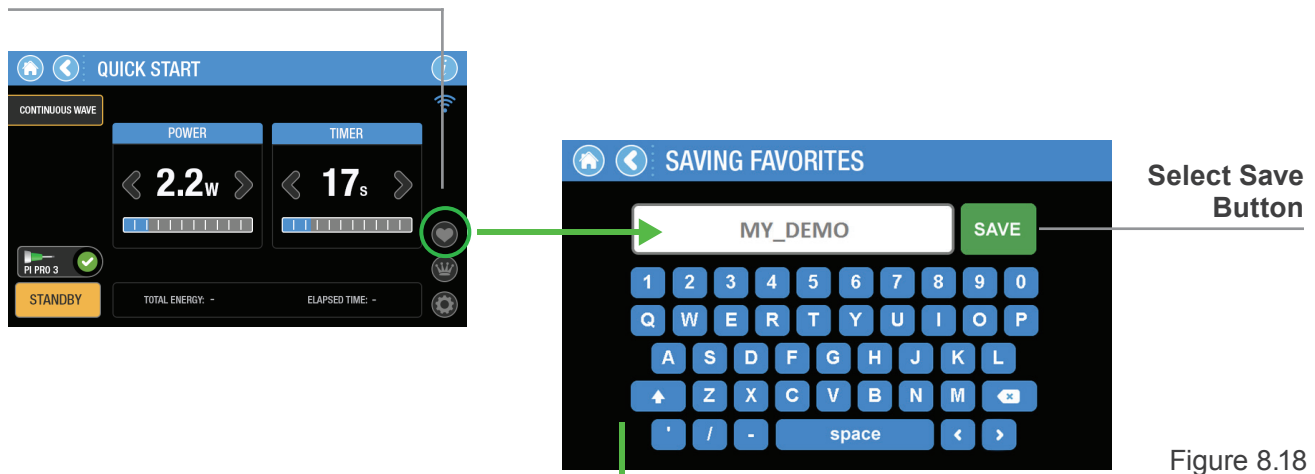

Figure 8.18

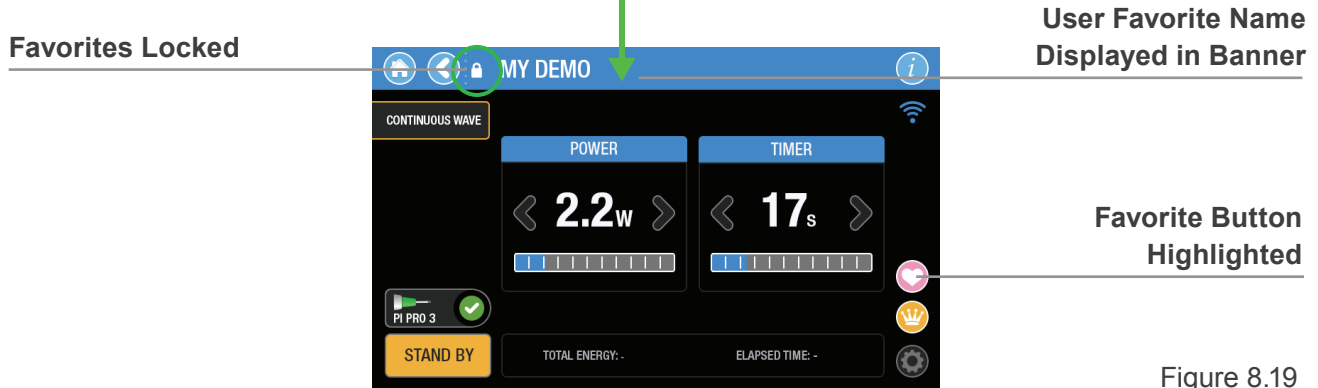

Figure 8.19

8 Operating Instructions

If a Favorites procedure is selected, but any of the parameters that appear on the screen are changed, the locked lock will change to an unlocked lock. The new settings may be saved by pressing the Favorites icon at the bottom right of the display; the name of the procedure will remain the same unless the modified settings are saved as a new Favorites.

To permanently delete a Favorites entry, press and hold the procedure name displayed on the screen for **4 seconds**. A screen requesting confirmation will always appear before the procedure is deleted (Figure 8.20).

While in the Favorites selection screen, Epic Pro is in **Standby** and cannot emit laser energy.

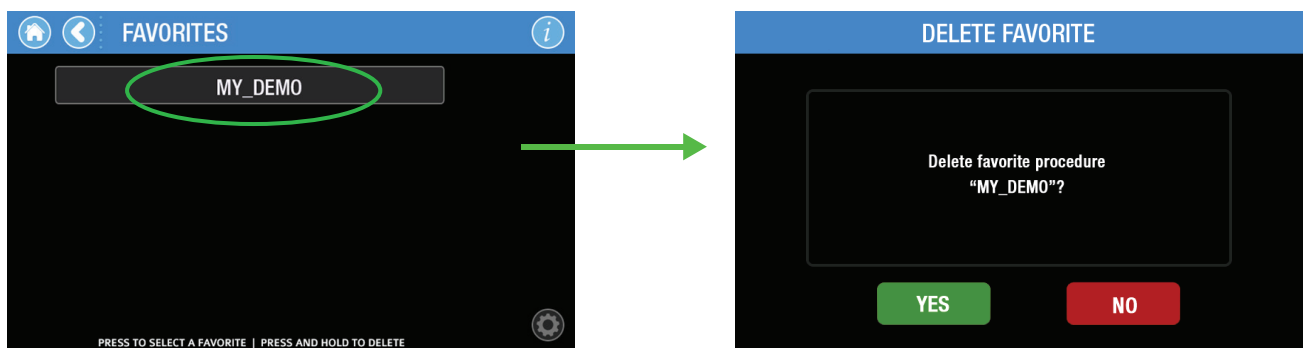

Figure 8.20

8 Operating Instructions

8.3.14 SELECTING A FAVORITES PROCEDURE

To access the Favorites screen, select Favorites on the Home screen; all custom procedures previously saved will be displayed (Figure 8.21). This list is created solely by the user; it is empty by default when the system is first installed.

Select from the procedures listed. Once a selection is made, the Main operating screen is displayed with the saved parameters ready for use. Navigate through the full list of Favorites by using the up and down arrows.

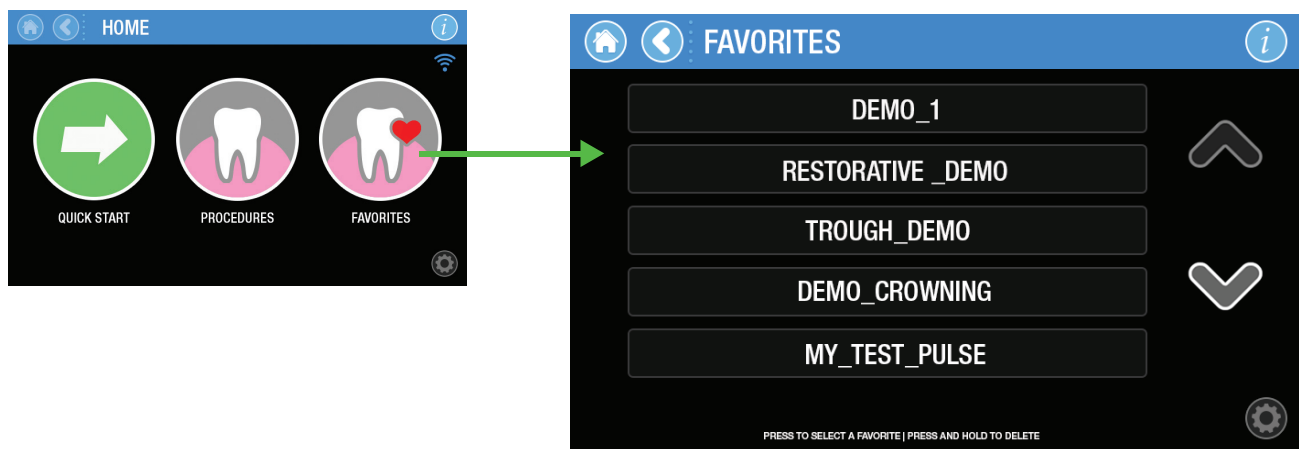

Figure 8.21

8.3.15 READY MODE

Epic Pro will only emit laser energy when the Foot Pedal is pressed while the console is in **Ready** mode. Press the **Standby** button on the bottom left of the screen to shift from **Standby** to **Ready**.

To return to **Standby**, press the **Ready** button on the bottom right of the screen.

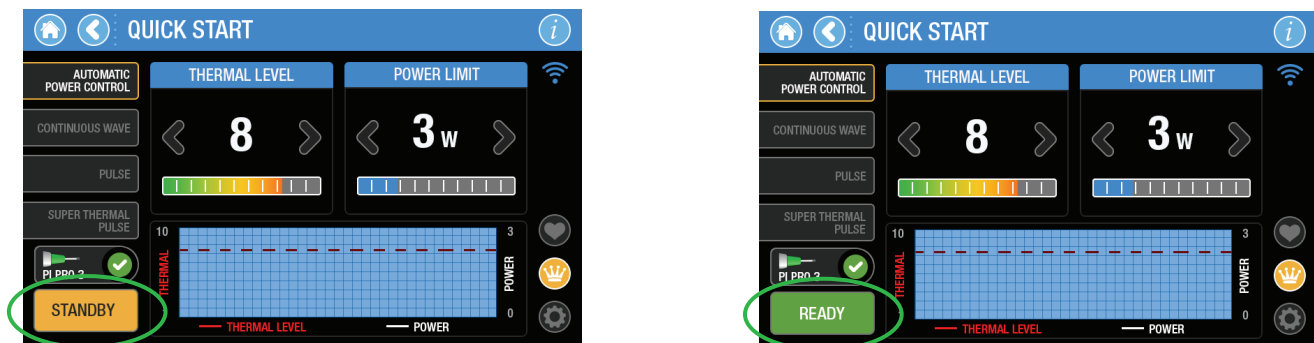

Figure 8.22

8 Operating Instructions



CAUTION: The aiming beam is on only when the laser is in **Ready** mode or when adjusting the brightness of the beam through the Settings menu. If the aiming beam is not visible in either instance, remove the Handpiece and confirm the beam is actually on by shining the end of the Fiber Optic Cable on a plain, non-reflective surface. **DO NOT** look directly at the output end of the Fiber Optic Cable. If the aiming beam is not on, turn off the laser console, then remove and re-install the Fiber Optic Cable (see Section 7.3). If the aiming beam is still not detected, turn the laser console off and call BIOLASE Service.



LASER WARNING: Never point the laser at a person's eyes. All persons present in the operatory must wear appropriate protective eyewear when the laser is in use.

8.3.16 FIRING THE LASER

Pressing the wireless Foot Pedal while the laser is in **Ready** mode will cause the laser to fire; a beeping sound indicates that laser energy is present.

While the laser is firing, the main treatment screen disables all operator options, such as mode and/or power setting adjustments, Tip selection, etc. The laser will continue to fire until the Foot Pedal is no longer pressed. Once the Foot Pedal is disengaged, the laser will stop emitting laser energy. Press the Ready button to go to **Standby**.

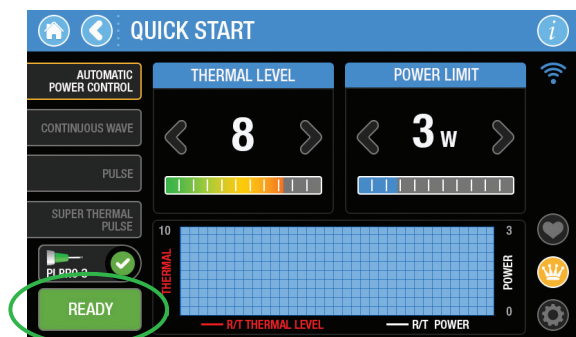

Laser in Ready mode, foot pedal not pressed

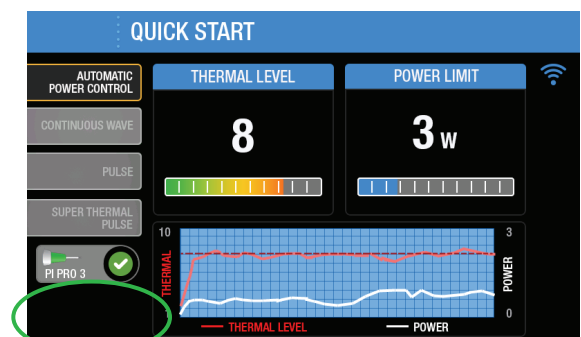

Foot pedal pressed/laser firing

Figure 8.23

8 Operating Instructions

8.3.17 SYSTEM SETTINGS MENU

Pressing the Settings icon allows the user to make changes to the system parameters (Figure 8.24); this menu can be reached from any screen displaying this Settings icon:

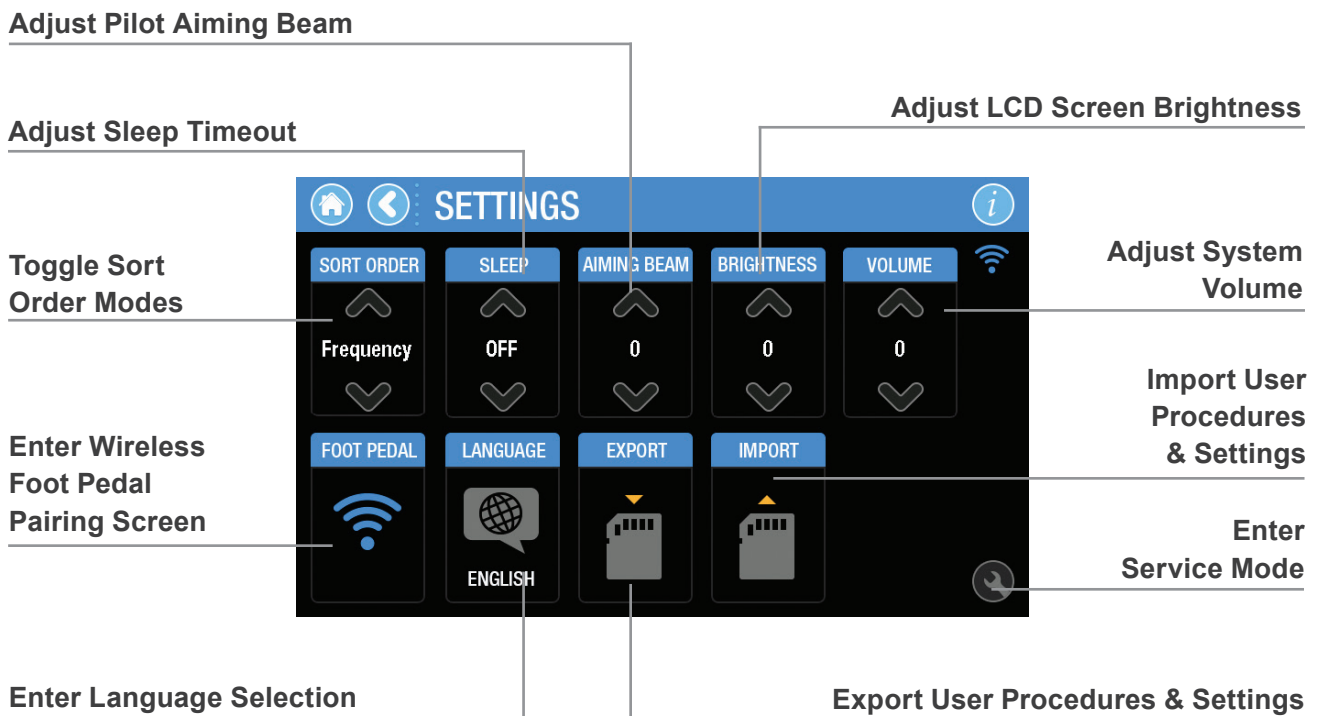

Figure 8.24

8 Operating Instructions

8.3.18 SYSTEM INFORMATION AND SOFTWARE UPDATES:

System information, such as the system serial number, software revision, GUI configuration, BootLoader version, and hardware revision are displayed by pressing the system information icon located in the upper right hand corner of any screen (Figure 8.25).

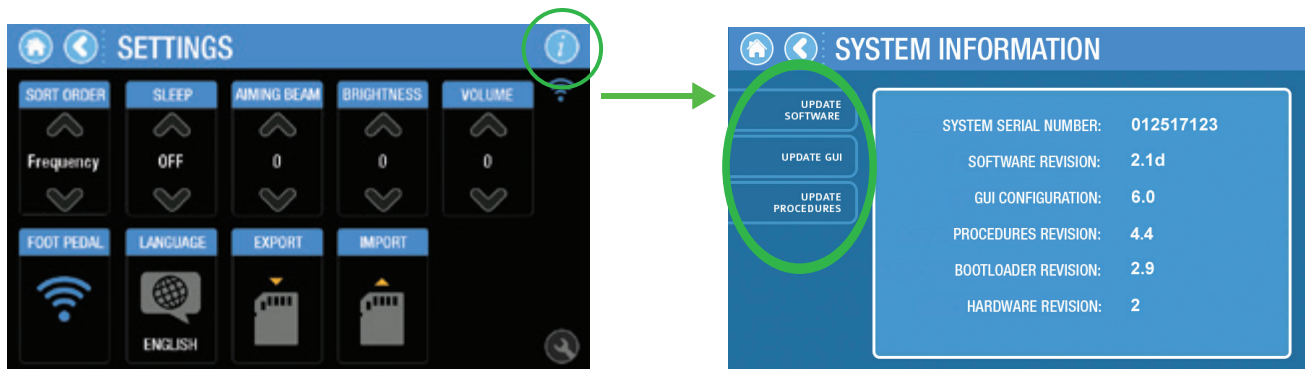

Figure 8.25

This screen also allows the user to implement the following changes (Figure 8.25).

Update Software: From time to time, BIOLASE may provide updated software with new functionalities by supplying the user with a programmed SD card.

- Remove the installed SD card from the SD card slot on the side of the console and set it aside as it will be required at the end of the update process.
- Insert the card into the SD card slot and press the “Update Software” button to start the upgrade process
- The screen will display a confirmation screen before initiating the update (Figure 8.26)
 - If “Yes” is selected, the system will begin the update
 - If “No” is selected, the system will revert to the System Information Screen

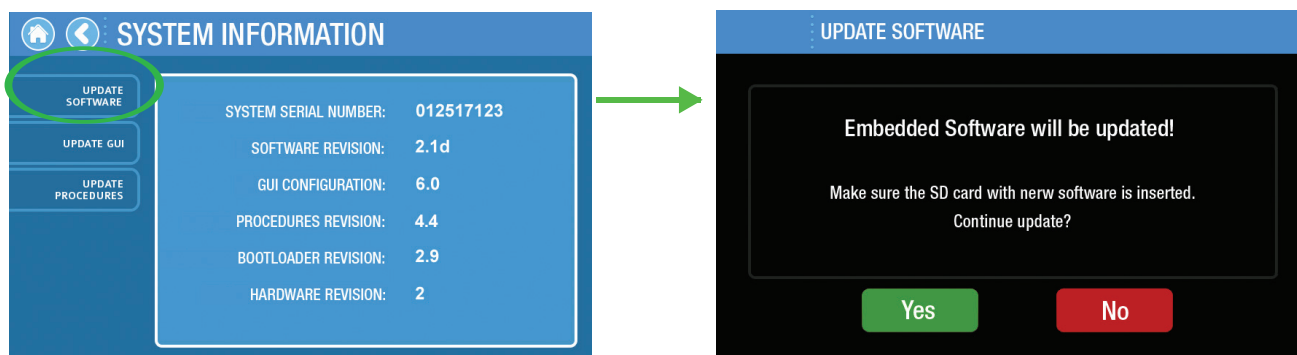

Figure 8.26

8 Operating Instructions

If a valid application software file is detected on the SD card, the update is initiated. The system screen will temporarily turn off. When completed, the system will reboot to the splash screen logo and Welcome screen. The system beep is audible during the update process.

If no SD card is inserted, the SD card is improperly formatted, or the application software file on the SD card is corrupted, the program will display an error message after the Update Software button is selected by the operator (Figure 8.27). If this occurs, replace the SD card with a known good card and a genuine copy of the application software file to be uploaded.

Once the update is complete, remove the Update SD card and replace it with the originally installed SD card and dispose of the Update SD card.

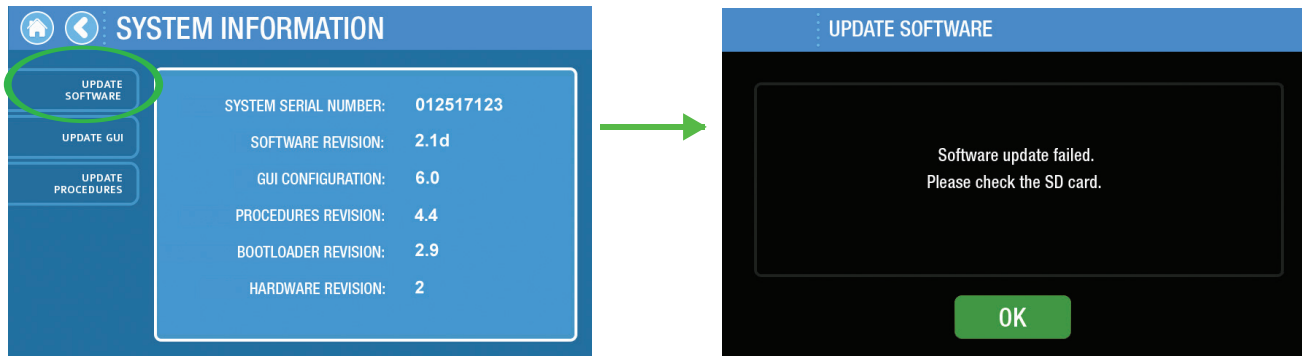

Figure 8.27

Update GUI: BIOLASE will provide the user with a programmed SD card whenever an update to the GUI is necessary.

- Remove the installed SD card from the SD card slot on the side of the console and set it aside as it will be required at the end of the update process.
- Insert the card into the SD card slot and press the “Update GUI” button to start the upgrade process.
- The screen will display a confirmation screen before initiating the update (Figure 8.28).
 - If “Yes” is selected, the system will begin the update.
 - If “No” is selected, the system will revert to the System Information Screen

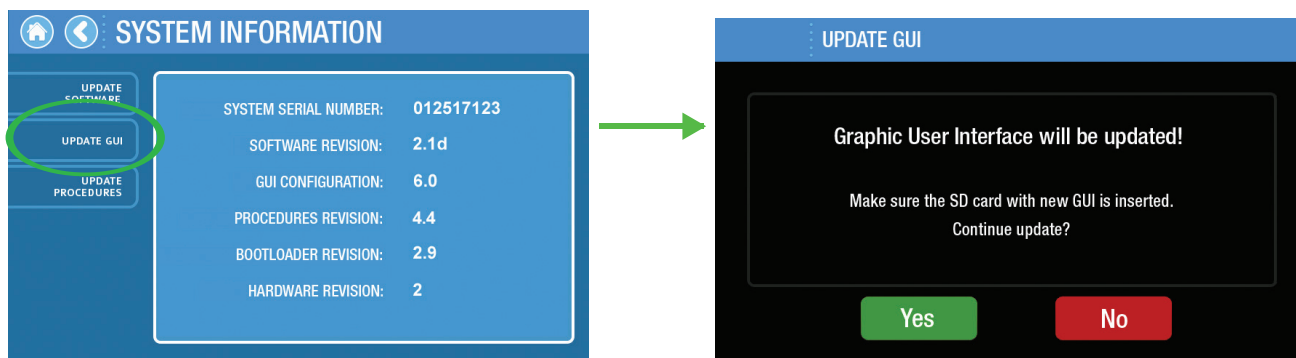

Figure 8.28

8 Operating Instructions

If a valid GUI configuration file is detected on the SD card, the program will begin the update process. The system screen will temporarily turn off and then reboot to a blue screen. The system memory is erased and then replaced with the new GUI configuration file from the SD card. A status bar at the bottom of the screen measures progress, while a number value on the top right corner displays the percentage completed (Figure 8.29). When finished, the system will reboot to the splash screen logo and Welcome screen. Updating the GUI takes approximately 20-25 minutes to complete.



Figure 8.29

If no SD card is inserted, the SD card is improperly formatted, or the GUI configuration file on the SD card is corrupted, the program will display an error message after the Update GUI button is selected by the operator (Figure 8.30). If this occurs, replace the SD card with a known good card and a genuine copy of the GUI configuration file to be uploaded.

Once the update is complete, remove the Update SD card and replace it with the originally installed SD card and dispose of the Update SD card.

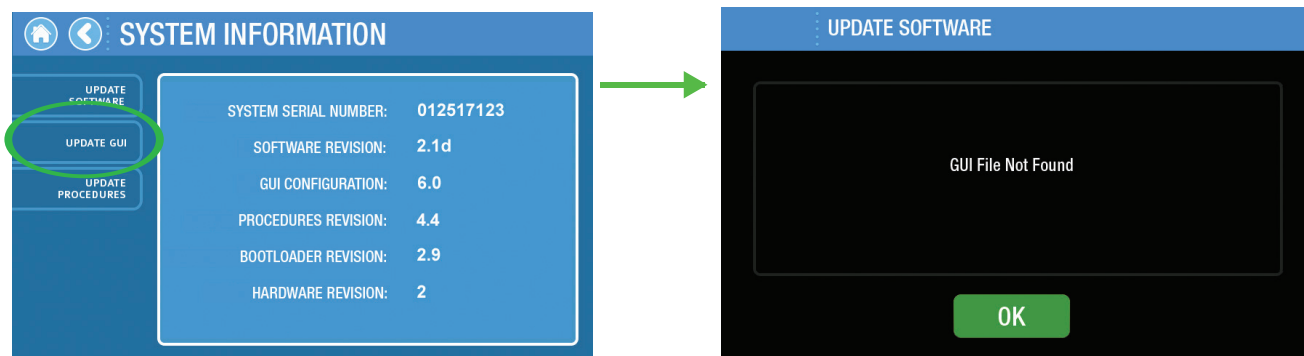

Figure 8.30

8 Operating Instructions

Update Procedures: BIOLASE will provide the user with a programmed SD card if any updates to the preset treatment parameters have made.

- Remove the installed SD card from the SD card slot on the side of the console and set it aside as it will be required at the end of the update process.
- Insert the card into the SD card slot and press the “Update Procedures” button to start the upgrade process
- The screen will display a confirmation screen before initiating the update (Figure 8.31)
 - If “Yes” is selected, the system will begin the update
 - If “No” is selected, the system will revert to the System Information Screen

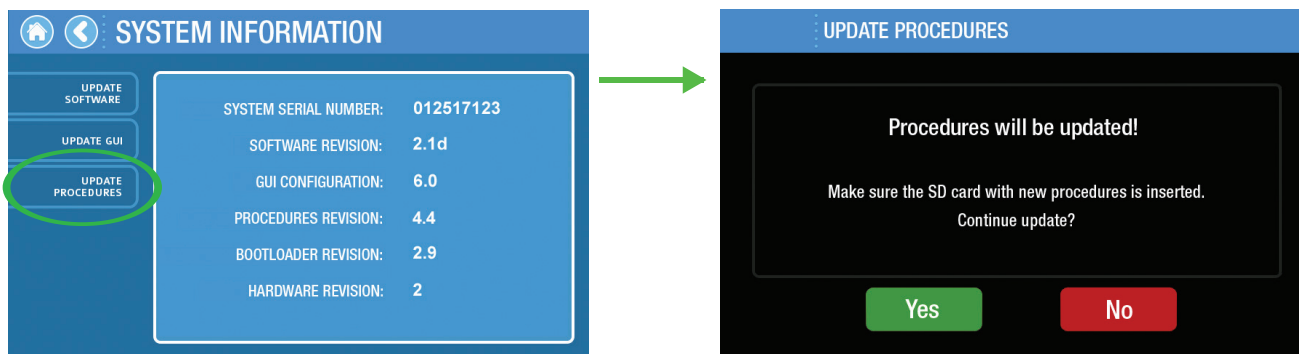

Figure 8.31

If a valid factory procedures configuration file is detected on the SD card, the program will begin the software update. The system will display a blue screen briefly, then display a status of “Update Complete” when the routine is done. Upon completion, the system will reboot to the splash screen logo and Welcome screen. Updating the factory procedures takes approximately 5 seconds to complete (Figure 8.32).



Figure 8.32

8 Operating Instructions

If no SD card is inserted, the SD card is improperly formatted, or the procedures configuration file on the SD card is corrupted, the program will display an error message after the Update Procedures button is selected by the operator (Figure 8.33). If this occurs, replace the SD card with a known good card and a genuine copy of the factory procedures configuration to be uploaded.

Once the update is complete, remove the Update SD card and replace it with the originally installed SD card and dispose of the Update SD card.

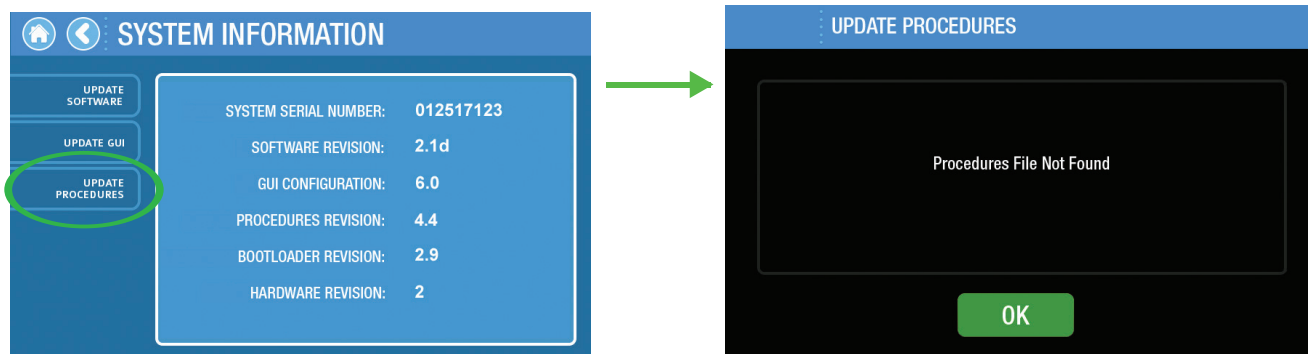

Figure 8.33



CAUTION: Please contact BIOLASE Customer Care immediately if any of the above update processes results in an error message.

8 Operating Instructions

8.3.19 SERVICE MODE:

The Epic Pro software includes a service mode which is password-protected and may only be accessed by trained service personnel. To return to the previous screen, press the “Back” button.

8.3.20 EXPORT AND IMPORT OF SETTINGS AND FAVORITES

Exporting settings to SD card: To preserve Favorite procedures and GUI settings when returning the Epic Pro to the BIOLASE Service Center for repair, export the information to an external storage device by inserting an Epic Pro SD card into the card slot on the left side of the console. Go to Settings and select Export to begin the process. Before proceeding, a screen will appear which requires the user to confirm the export command or cancel the operation (Figure 8.34). If cancel is selected, the system will return to the Settings screen; if export is confirmed, the program will begin to download data to the SD card.

While the export operation is in process, the screen will display a busy status followed by the results of the export operation. A screen will appear either confirming the export was successful, or that it failed (Figure 8.35). In either case, press OK to return to the main treatment screen.

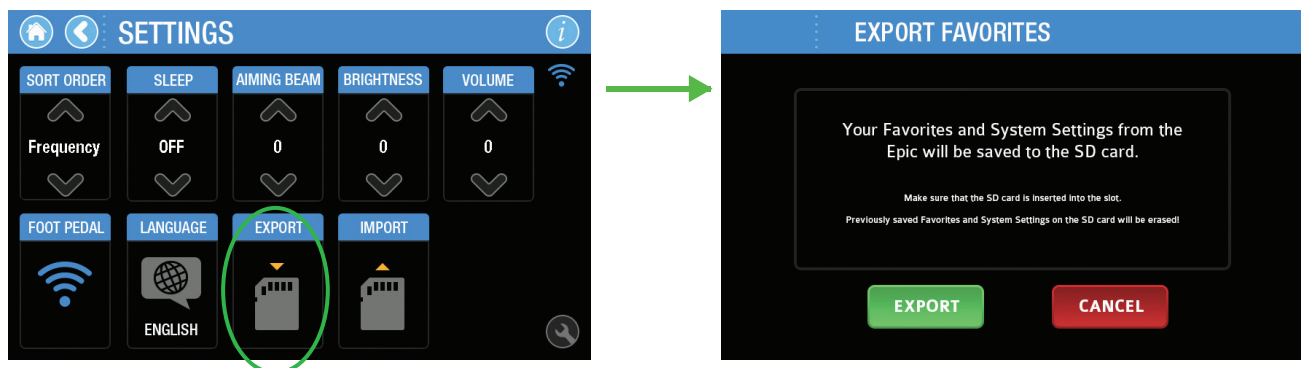

Figure 8.34

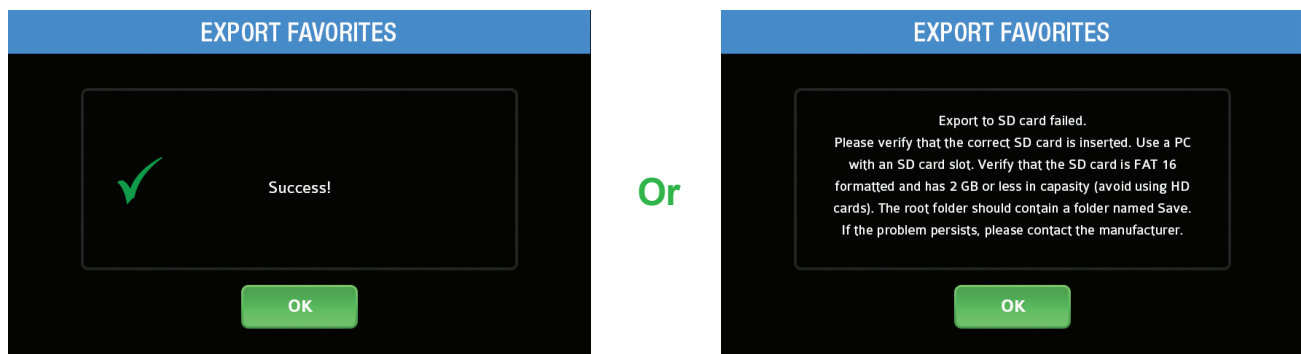

Figure 8.35

8 Operating Instructions

Importing settings from SD card: To transfer Favorites procedures and System settings to your Epic Pro, insert the Epic Pro SD card containing the information into the card reader slot on the left side of the console. Go to Settings and select Import to begin the process.

Before proceeding, a screen will appear which requires the user to confirm the import command or cancel the operation (Figure 8.36). If cancel is selected, the program will return to the Settings screen; if import is confirmed, the program will begin to download data to the Epic Pro console.

While the import operation is in process, the screen will display a busy status followed by the results of the import operation. A screen will appear either confirming the export was successful, or that it failed (Figure 8.37). In either case, press OK to return to the main treatment screen.

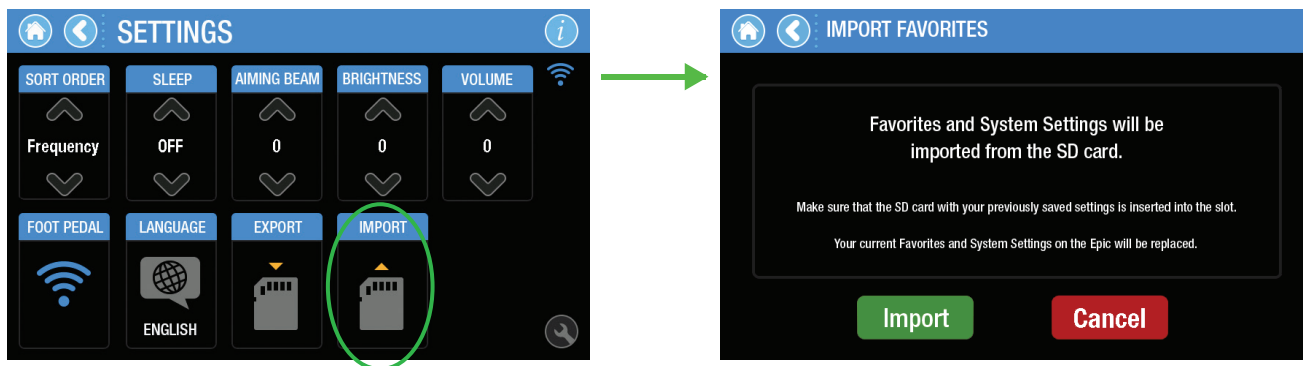

Figure 8.36

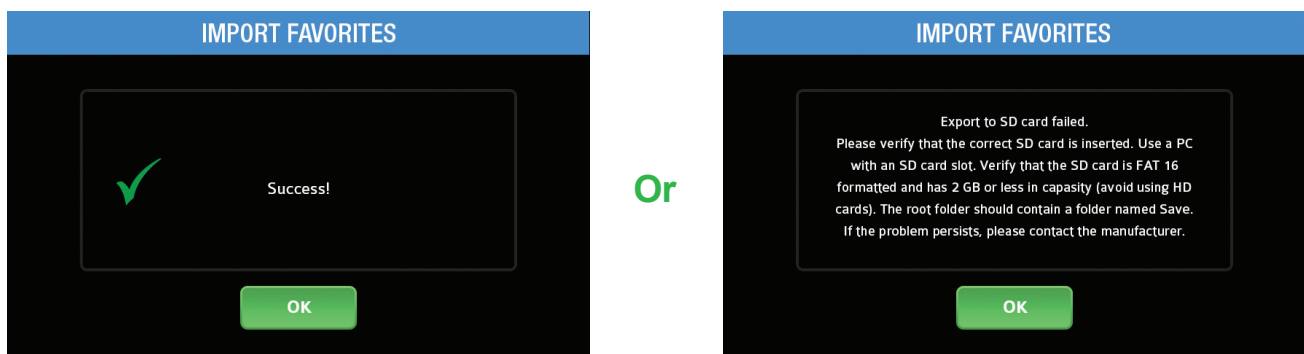

Figure 8.37

8.4 TURNING THE EPIC PRO OFF

To turn the Epic Pro off, return to the Home screen by pushing the Home icon, then press the Power Switch on the side of the console to the OFF position (O).

8 Operating Instructions

8.5 SYSTEM FLOW CHART

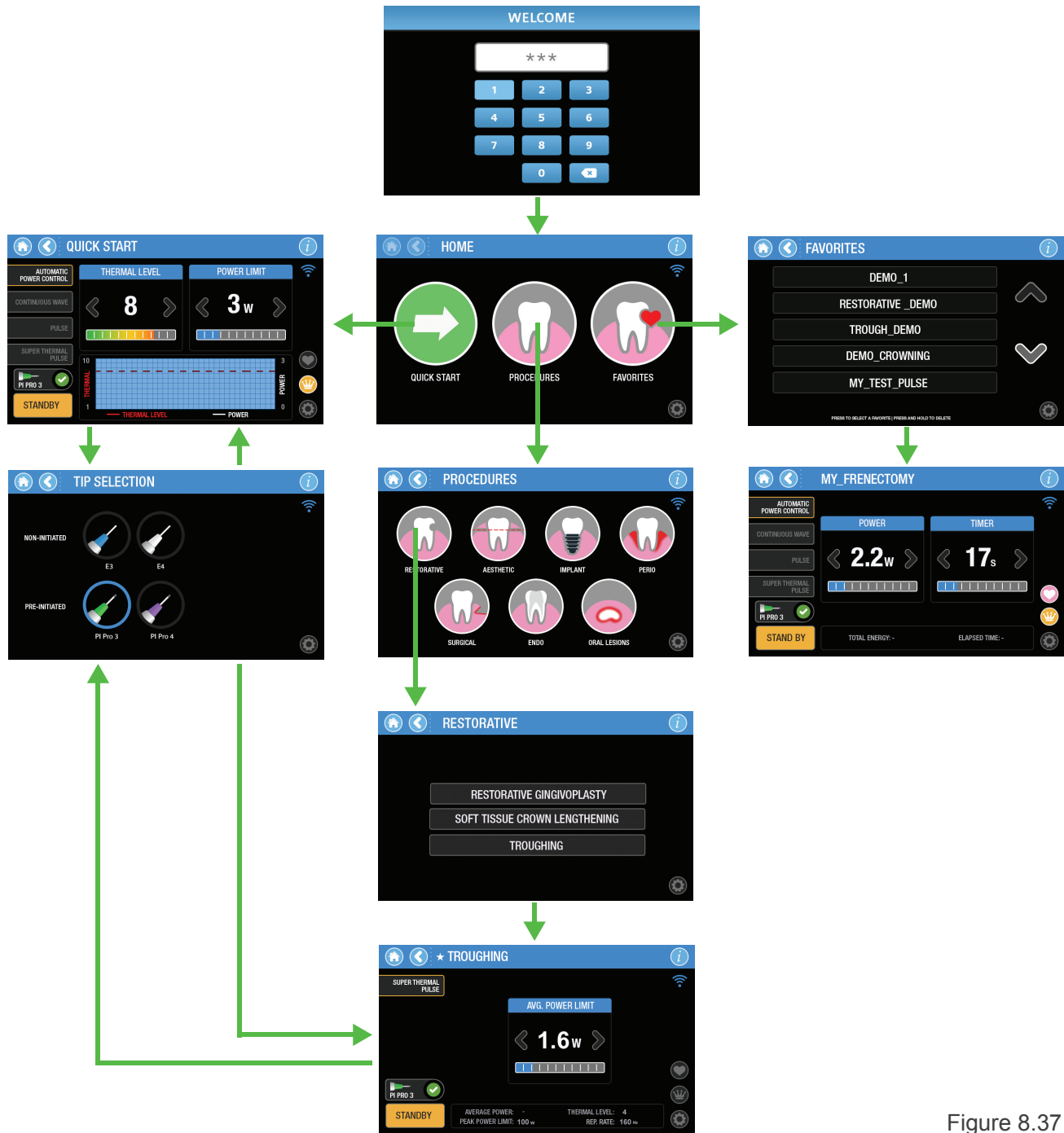

Figure 8.37

9 Presets

The settings chosen for a procedure will contribute to its overall success. Recommended settings have been pre-programmed into Epic Pro at the factory for different procedures in CW, APC, Pulse, and STP treatment modes. These settings may be modified, within specific parameters, and saved as Favorites.

Always use clinical judgment when making adjustments to power, pulse repetition rate, and treatment mode as may be necessary to compensate for variations in tissue composition, density, and/or thickness.



NOTE: N/A means the parameter is not directly modifiable by the user, but may be visible on the screen.

9.1 RESTORATIVE

Procedure	Treatment Mode (Range)	Thermal Level (Range)	Power Limit (Range)	Average Power (Range)	Pulse Width (Range)	Pulse Energy (Range)	Timer (Preset Value)	Tip Type
Gingivoplasty	STP	4	N/A	3.2W (2.4-5.6)	1 ms	N/A	N/A	PI PRO 4 Pre-initiated
Soft-Tissue Crown Lengthening	STP	4	N/A	3.2W (2.4-5.6)	1 ms	N/A	N/A	PI PRO 4 Pre-initiated
Troughing	STP	4	N/A	1.6W (1.6-3.2)	1 ms	N/A	N/A	PI PRO 3 Pre-initiated

9.2 AESTHETIC

Procedure	Treatment Mode (Range)	Thermal Level (Range)	Power Limit (Range)	Average Power (Range)	Pulse Width (Range)	Pulse Energy (Range)	Timer (Preset Value)	Tip Type
Aesthetic Contouring	STP	6	N/A	4W (2.4-5.6)	1 ms	N/A	N/A	PI PRO 4 Pre-initiated
Gingival Contouring	STP	6	N/A	4W (2.4-5.6)	1 ms	N/A	N/A	PI PRO 4 Pre-initiated
Teeth Whitening	CW	N/A	N/A	7W (3-7)	N/A	N/A	30s	Whitening Handpiece

9 Presets

9.3 IMPLANT

Procedure	Treatment Mode (Range)	Thermal Level (Range)	Power Limit (Range)	Average Power (Range)	Pulse Width (Range)	Pulse Energy (Range)	Timer (Preset Value)	Tip Type
Implant Uncovering	STP	3	N/A	3.2W (2.4-5.6)	1 ms	N/A	N/A	PI PRO 4 Pre-initiated
Soft-Tissue Contouring	STP	3	N/A	3.2W (2.4-5.6)	1 ms	N/A	N/A	PI PRO 4 Pre-initiated

9.4 PERIO

Procedure	Treatment Mode (Range)	Thermal Level (Range)	Power Limit (Range)	Average Power (Range)	Pulse Width (Range)	Pulse Energy (Range)	Timer (Preset Value)	Tip Type
Soft-Tissue Pocket Reduction	STP	4	N/A	3.2W (2.4-5.6)	1 ms	N/A	N/A	PI PRO 4 Pre-initiated
Sulcular Debridement	Pulse	N/A	N/A	1.2W (0.8-3.6)	10 ms	N/A	N/A	E3 Non-initiated

9.5 ORAL LESIONS

Procedure	Treatment Mode (Range)	Thermal Level (Range)	Power Limit (Range)	Average Power (Range)	Pulse Width (Range)	Pulse Energy (Range)	Timer (Preset Value)	Tip Type
Aphthous Ulcers	Pulse	N/A	N/A	1.2W (1-3)	1 ms	N/A	30s	E4 Non-initiated
Herpetic lesion	Pulse	N/A	N/A	1.2W (1-3)	1 ms	N/A	30s	E4 Non-initiated

9 Presets

9.6 SURGICAL

Procedure	Treatment Mode (Range)	Thermal Level (Range)	Power Limit (Range)	Average Power (Range)	Pulse Width (Range)	Pulse Energy (Range)	Timer (Preset Value)	Tip Type
Biopsy	STP	8	N/A	5.6W (3.2-6.4)	1 ms	N/A	N/A	PI PRO 4 Pre-initiated
Exposure of Unerupted Tooth	STP	6	N/A	4W (2.4-5.6)	1 ms	N/A	N/A	PI PRO 4 Pre-initiated
Frenectomy	STP	6	N/A	4W (2.4-5.6)	1 ms	N/A	N/A	PI PRO 4 Pre-initiated
Hemostatis	CW	N/A	N/A	0.5W (0.1-5)	N/A	N/A	10s	E4 Non-initiated
Operculectomy	STP	6	N/A	4W (2.4-5.6)	1 ms	N/A	N/A	PI PRO 4 Pre-initiated

9.7 ENDO

Procedure	Treatment Mode (Range)	Thermal Level (Range)	Power Limit (Range)	Average Power (Range)	Pulse Width (Range)	Pulse Energy (Range)	Timer (Preset Value)	Tip Type
Pulpotomy	CW	N/A	N/A	0.1W (0.1-5)	N/A	N/A	60s	E4 Non-initiated

10 Cleaning, Disinfection, and Sterilization

10.1 CLEANING THE CONSOLE

Use the screen protectors provided to keep water and debris from contaminating the touchscreen, and use a disinfectant to wipe down the console and Handpiece Holder after each procedure. **Do not use bleach or abrasive cleansers.**

10.2 CLEANING AND STERILIZATION PROCEDURES, HANDPIECE AND TIPS



CAUTION: Handpiece and Tips must be cleaned and sterilized prior to first-time use.

Handpieces are reusable and must be cleaned and sterilized between patients to avoid cross-contamination.

Tips are single-use only to avoid cross-contamination and are designed to withstand only a single sterilization cycle; discard in a biohazard medical waste sharps container after use.

The contamination control suggested for the Epic Pro Surgical Handpiece and Tips is steam sterilization. However, before sterilization, the Epic Pro reusable Handpiece should be MANUALLY cleaned per the following procedure.



CLEANING MUST BE PERFORMED WITHIN A MAXIMUM OF 1 HOUR AFTER THE PROCEDURE AND ALWAYS PRIOR TO STERILIZATION.

STEP 1 - CLEANING PROCESS (HANDPIECE)

The cleaning process is intended to remove blood, protein and other potential contaminants from the surfaces and crevices of reusable accessories. This process may also reduce the quantity of particles, microorganisms and pathogens present. Cleaning should be performed **prior** to sterilization and must be conducted by qualified office personnel trained to perform the procedure.

Wear protective latex gloves when handling the contaminated delivery system.

1. After each use, carefully remove the tip from the Handpiece and discard in a biohazard medical waste sharps container.
2. Carefully disconnect the Handpiece from the Fiber Optic Cable by taking the Handpiece body in one hand and the shaft in the other, then pressing both buttons at the base of the fiber shaft and gently pulling the Handpiece by the collar to separate it from the shaft without twisting.
3. Prepare any commercially available surgical instrument detergent/enzymatic cleaning solution with a pH of 7.0, such as Enzol® or similar enzymatic presoak and cleaner, per the manufacturer's instructions. (Follow the manufacturer's instructions for disposal of used solution.)
4. Rinse the Handpiece under running lukewarm tap water (22 – 43°C) for a **minimum of 10 seconds** to remove gross soil.

10 Cleaning, Disinfection, and Sterilization

5. Wrap the Handpiece in a piece of gauze that has been soaked in the cleaning solution; leave it wrapped in the gauze for a **minimum of 10 minutes**.
6. Unwrap the Handpiece from the gauze and use a soft-bristled brush dipped in the cleaning solution to gently scrub it for **at least 15 seconds**.
7. Rinse the Handpiece under running lukewarm tap water (22-43°C) for a **minimum of 10 seconds** and then dry with a lint-free cloth.
8. Visually inspect the Handpiece for any residual soil. If necessary, repeat steps 5 - 7 until **all** residual soil is removed.

STEP 2 - STEAM STERILIZATION FOR SURGICAL HANDPIECE, SINGLE USE TIPS

The steam sterilization process is intended to destroy infectious microorganisms and pathogens.



CAUTION: Always perform the procedure immediately after cleaning and prior to use and only use FDA-cleared (USA) sterilization accessories, i.e., sterilization pouch and autoclave tray. The product packaging is not suitable for steam sterilization.

- Place the Handpiece and fiber Tips in separate single-wrap, self-seal autoclave pouches
- Place on an autoclave tray; do not stack other instruments on top of the pouches
- Place the tray inside the autoclave chamber and set the appropriate cycle as recommended in Figure 10.1
- Once the cycle is completed, remove the tray and let each sterilized item cool and dry. **The Handpiece and Tips must remain in the sterilization pouches until used in order to maintain sterility**
- Reassemble the Handpiece by pushing the Handpiece onto the fiber shaft until it clicks into place and is secured (See Section 7)

Type of Sterilizer	Temperature	Minimum Time	Drying Time
Gravity Displacement	121°C (250°F)	30 minutes	15 – 30 minutes
	132°C (270°F)	15 minutes	
Dynamic-Air-Removal (Pre-Vacuum)	132°C (270°F)	4 minutes	20 – 30 minutes
	134°C (273°F)	3 minutes	20 minutes

Figure 10.1

10 Cleaning, Disinfection, and Sterilization

10.3 DISINFECTING THE FIBER OPTIC CABLE

Wear protective latex gloves when handling the contaminated delivery system.

Always disinfect the fiber between patients by wiping it completely with an appropriate disinfecting solution such as Cavicide™ or a similar quaternary ammonium compound product (containing 20% alcohol or less), and follow the manufacturer's instructions. **DO NOT AUTOCLAVE.**

10.4 DISINFECTING THE WHITENING HANDPIECE

The Whitening Handpiece is sold with disposable non-sterile protective shields. **Neither the Handpiece nor the disposable protective shields can be sterilized in the autoclave.**

To disinfect the Whitening Handpiece, wipe it down with gauze and isopropyl alcohol.

Always wipe the disposable protective shield with alcohol prior to use. **Discard after single use;** these are intended for one-time use only and should never be reused to prevent cross-contamination.

11 Maintenance and Calibration

11.1 ANNUAL CALIBRATION

Epic Pro should be calibrated every 2 years in order to maintain the required accuracy of output power versus displayed power. Calibration can be performed at a certified depot repair facility. Call BIOLASE Service at **1-800-321-6717** or your Authorized Service representative for instructions on how to return the laser for service.

11.2 CHANGING THE WIRELESS FOOT PEDAL BATTERIES

The wireless Foot Pedal is powered by two AAA batteries. When the batteries are low, the green LED on the Foot Pedal cover will blink and a warning message will appear on the screen indicating that the batteries need to be replaced.

To replace the batteries:

1. Close the Foot Pedal cover (Figure 11.1).
2. Use a coin to remove the battery compartment cover on the side of the Foot Pedal by turning it counter-clockwise (Figure 11.2).
3. Remove the depleted batteries from the compartment and insert two new batteries (Figure 11.3).
4. Replace the battery compartment cover; turn clockwise to secure.

In the unlikely event that pairing of the laser console and Foot Pedal is disrupted when the batteries are replaced, the message "**FOOT PEDAL NOT DETECTED**" will appear on the touchscreen; re-establish pairing by following the instructions outlined in Section 7.7.

Replace both batteries at the same time; do not mix old and new batteries. **Old batteries must be discarded as regulated; do not throw them in a trash bin.**

To ensure the longevity of the Foot Pedal's battery power, only use BIOLASE-supplied batteries as replacements (P/N 6400463); these are industrial-grade and under normal use have a longer life than conventional AAA batteries.



Figure 11.1



Figure 11.2



Figure 11.3

11 Maintenance and Calibration

11.3 FIBER CABLE LENS INSPECTION AND CLEANING



CAUTION: DO NOT inspect the lens while the laser system is powered on; **the aiming beam or laser beam can permanently impair vision if aimed at the eye.**



CAUTION: Never reuse single-use Tips as this will damage the Fiber Optic Cable lens.

11.3.1 LENS INSPECTION PROCEDURE

The lens is at the distal end of the Fiber Optic Cable (Figure 11.4); this is where debris may accumulate with use. To inspect the lens, take the following steps:

1. Remove the Handpiece from the fiber shaft.
2. Inspect the distal end of the fiber using a magnifier or loupes with at least 10X magnification (Figure 11.5).
3. Inspect the lens.



Figure 11.4

11.3.2 CLEANING THE LENS:

If debris or dark spots are observed on the lens, clean the window using the procedure outlined below.

1. Always use a new, unused Microbrush to clean the lens provided (Figure 11.6).
2. Dip the Microbrush in isopropyl alcohol.
3. Gently rub the lens surface to remove debris or dark spots (Figure 11.7).
4. Repeat as needed using a new Microbrush each time until no residue appears on the swab.

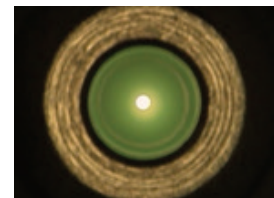

Figure 11.5



Figure 11.6



CAUTION: If blemishes appear below or inside the lens, contact BIOLASE or your authorized service representative to order a replacement lens.

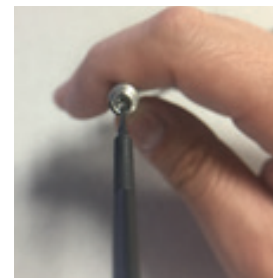

Figure 11.7

12 Troubleshooting

If the system detects a system fault while on the main treatment screen, an Error button appears in the bottom left hand corner of the screen. Pressing the button will display information related to the error (Figure 12.1). It will not be possible to enter **Ready** or **Standby** modes until the fault is resolved.

If after following the directions on the screen the error does not clear, please call your local BIOLASE Service Representative for assistance.

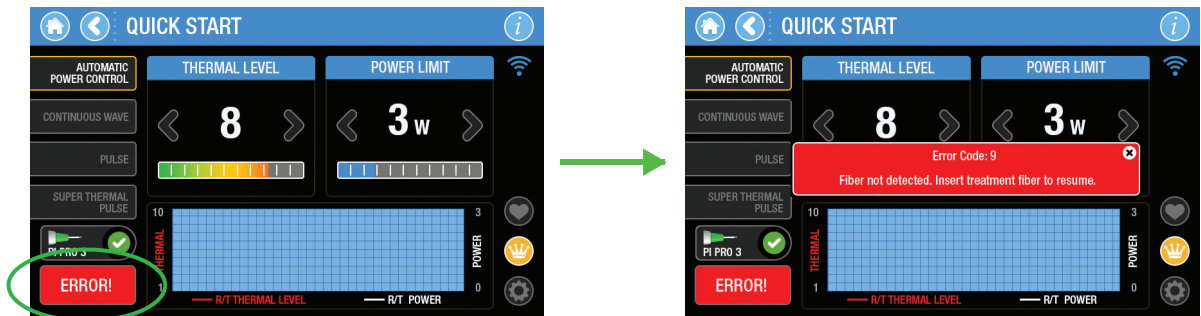

Figure 12.1

Error	Message	Reason(s)	Fix	
1	Door interlock disconnected	Error Code: 1 Insert door interlock	Remote interlock connector not inserted on left side panel of system	Insert remote interlock
2	Laser overheating	Error Code: 2 Laser overheating. Wait until cools down. Reduce room temperature if possible	Laser temperature detected greater than 50°C	Allow system to cool for 5-10 minutes. If problems persist, contact the manufacture for evaluation
3	Laser temperature too low	Error Code: 3 Laser temperature sensor malfunction. Please contact the manufacturer	Laser temperature detected less than 10°C	Allow system to reach ambient room temperature. If problems persist, contact the manufacturer for evaluation
4	Power transistor overheating	Error Code: 4 Device overheating. Please contact the manufacturer	Power transistor temperature detected greater than 75°C	Allow system to cool for 5-10 minutes. If problems persist, contact the manufacturer for evaluation

12 Troubleshooting

Error	Message	Reason(s)	Fix	
5	Power transistor temp too low	Error Code 5: Internal temperature sensor malfunction. Please contact the manufacturer	Power transistor temperature detected less than 10°C	Allow system to reach ambient room temperature. If problems persist, contact the manufacturer for evaluation
6	Optical Feedback Out of Range	Error Code 6: Power Calibration Failed. Please contact manufacturer	Optical feedback detected a value out of the calibrated range	Contact the manufacturer
7	Voltage Reference	Error Code 7: Voltage reference failure	Voltage feedback out of range	Contact the manufacturer
8	Foot Pedal pressed while not in ready state	Error Code 8: Release footswitch. If it is not pressed, replace the Foot Pedal	Foot Pedal pressed down while entering Ready Mode from Standby Mode	Release the Foot Pedal and attempt to re-enter Ready Mode
9	Fiber Not Detected	Error Code 9: Fiber not detected. Insert treatment fiber to resume	Fiber not inserted into system	Fully insert fiber SMA connector into the optical port as described in Section 7.3. If problem persists, contact the manufacturer for evaluation
10	Laser current exceeds set value	Error Code 10: Internal error with current setting	Current feedback detected current out of acceptable range	Contact the manufacturer
11	APC Temperature Feedback	Error Code 11: Cannot achieve set temperature	Temperature feedback setting was not able to be verified by software within 5 seconds of emission	Confirm a pre-initiated tip is installed to the end of fiber. Confirm pre-initiated tip did not lose its initiated state. If problems persist, contact the manufacturer for evaluation

12 Troubleshooting

Error	Message	Reason(s)	Fix	
12	Calibration Data Corrupted	Error Code 12: System calibration data stored in internal memory has been compromised	System calibration data could not be verified for integrity	Contact the manufacturer
13	Optical module overheating	Error 13: Optical module overheating	Optical temperature detected greater than 50°C	Allow system to cool for 5-10 minutes. If problems persist, contact the manufacturer for evaluation
14	Optical module temperature too low	Error 14: Optical module temperature too low	Optical temperature detected less than 10°C	Allow system to reach ambient room temperature. If problems persist, contact the manufacturer for evaluation
16	Factory Procedure Data Corrupted	Error 16: Factory procedure data corrupted. Please contact the manufacturer	System memory corrupted	Copy valid procedures file onto SD card and attempt to Update Procedures through System Information screen
17	System Clock Failure	Error 17: System Clock Failure	Main controller board system clock not operating correctly	Contact the manufacturer
18	Cap Voltage Error	Error 18: Main controller board capacitor voltage out of range	Main controller board capacitor's voltage is out of acceptable range	Contact the manufacturer

Figure 11.2

13 Transportation and Storage

13.1 TRANSPORTATION

The Epic Pro is susceptible to damage if not handled properly. The unit should ALWAYS be handled carefully and never banged, jarred, dropped, or knocked.

Do not transport the unit unless it is completely packaged inside its shipping box. If you have any questions regarding transportation, please call BIOLASE Service at 1-800-321-6717 (949-273-6691).

13.2 STORAGE

The Epic Pro should be stored in a cool, dry place when not in use under the following environmental conditions:

- Storage temperature: 15 °C - 35 °C (59 °F - 95 °F)
- Relative humidity: 10% - 90%, non-condensing

Cover the unit when not in use for extended periods of time. Store the system in a place where it will not be accidentally bumped or banged.

The Epic Pro is shipped inside a custom shipping box. Please save and store the box in a cool, dry place for use when transporting the laser, or for long-term storage.



CAUTION: Make sure the distal end of the fiber shaft is protected from dirt by removing the Handpiece and installing the red protective cap over the end of the fiber.



CAUTION: Remove the batteries from the Footswitch if the Epic Pro is not likely to be used for some time.



NOTE: At end-of-life, final disposition of this laser must be done as required by local waste electrical and electronic equipment (WEEE) laws.

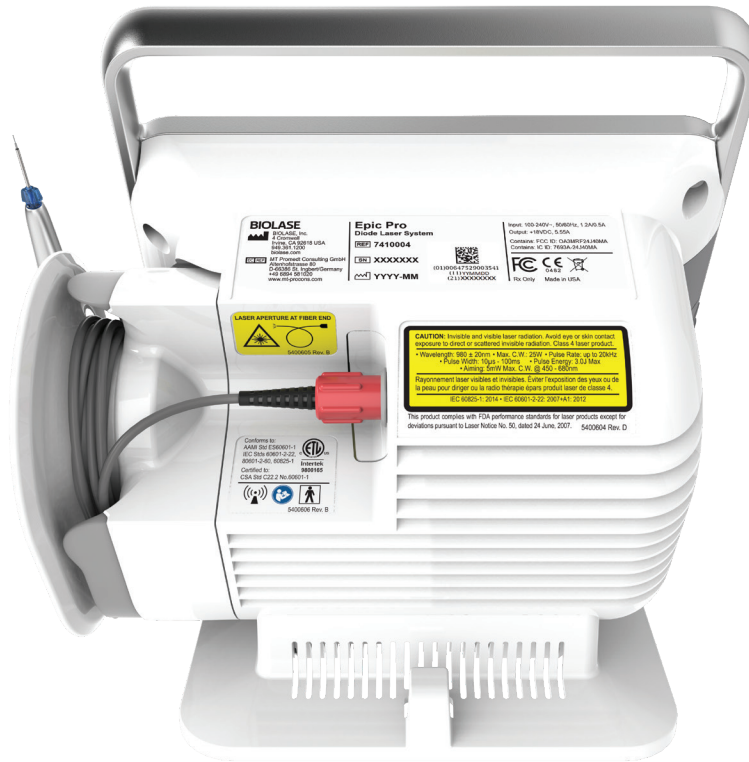

Appendix A Labels



PRODUCT IDENTIFICATION LABEL:

LOCATION:

Top of laser console

 BIOLASE, Inc. 4 Cromwell Irvine, CA 92618 USA 949.361.1200 biolase.com	Epic Pro Diode Laser System	Input: 100-240V~, 50/60Hz, 1.2A/0.5A Output: +18VDC, 5.55A Contains: FCC ID: OA3MRF24J40MA Contains: IC ID: 7693A-24J40MA
	REF 7410004 SN XXXXXXX YYYY-MM (01)00647529003541 (11)YYMMDD (21)XXXXXXXXXX	

LASER APERTURE WARNING:

LOCATION:

Back of console











FCC AND IC ID LABEL:

LOCATION:

Bottom of wireless Foot Pedal

Contains: FCC ID: OA3MRF24J40MA IC ID: 7693A-24J40MA	
5201522 Rev. C	

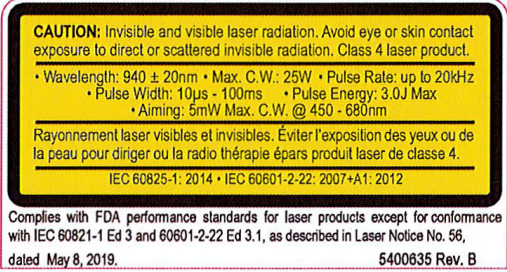
Appendix A Labels

<p>MANUFACTURER</p>	
<p>CATALOG/PART NUMBER</p>	
<p>PRODUCT SERIAL NUMBER</p>	
<p>DATE OF MANUFACTURE</p>	
<p>LASER WARNING SYMBOL: Indicates the system contains a laser</p> <p>LOCATION: Back of laser console</p>	
<p>FCC DECLARATION OF CONFORMITY: Electromagnetic interference is under limits approved by the Federal Communications Commission</p>	
<p>RX ONLY (US) Federal Law restricts this device to sale by or on the order of a dentist or other licensed dental practitioner</p>	<p>Rx Only</p>
<p>LASER EXPLANATORY AND CERTIFICATION LABEL:</p> <p>LOCATION: Back of console</p>	
<p>ELECTRICAL SHOCK HAZARD</p>	

Appendix A Labels

ETL LABEL:

Meets Product Safety Standards

LOCATION:



Back of console

Conforms to:
 AAMI Std ES60601-1
 IEC Std 60601-2-22, C
 80601-2-60, 60825-1

ETL CLASSIFIED
 US

Intertek
 9800165

Certified to:
 CSA Std C22.2 No.60601-1

5400622 Rev. B

NON-IONIZING RADIATION:

Device includes an international radiator (Bluetooth)



REFER TO USER MANUAL



TYPE BF APPLIED PART:

The applied part is not conductive to the patient



FCC COMPLIANCE NOTICE:

LOCATION:

Bottom of wireless Foot Pedal

NOTICE
 This device complies with Part 15 of FCC Rules. Operation is subject to the following two conditions: (1) this device may not cause harmful interference, and (2) this device must accept any interference received, including interference that may cause undesired operation.

LASER WARNING SIGN

Included in the welcome kit; must be placed **outside of the operatory** whenever the laser system is in use.

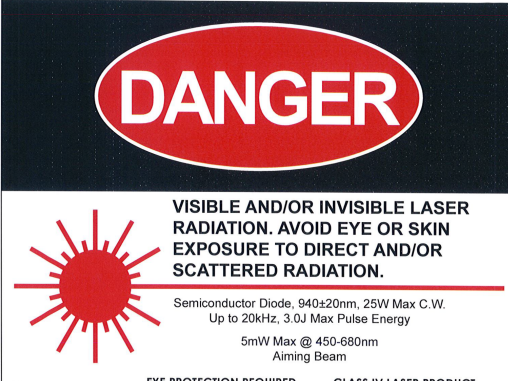

DANGER

VISIBLE AND/OR INVISIBLE LASER RADIATION. AVOID EYE OR SKIN EXPOSURE TO DIRECT AND/OR SCATTERED RADIATION.

Semiconductor Diode, 940±20nm, 25W Max C.W.
 Up to 20kHz, 3.0J Max Pulse Energy







5mW Max @ 450-680nm
 Aiming Beam

EYE PROTECTION REQUIRED CLASS IV LASER PRODUCT

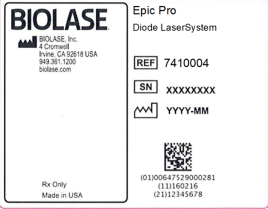
INVISIBLE AND VISIBLE LASER RADIATION



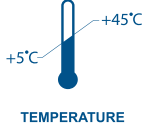
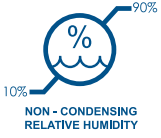
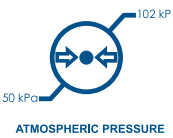

Appendix A Labels

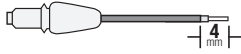
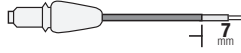
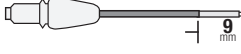
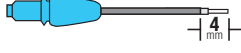

SHIPPING LABEL LOCATION: Outer carton/shipping box	
SINGLE USE ONLY – DO NOT REUSE (SINGLE-USE ACCESSORIES)	
WEEE (WASTE ELECTRICAL AND ELECTRONIC): Recycle lithium ion battery as regulated. Do not throw in trash bin.	
THIS END UP LOCATION: Outer carton (shipping box)	
FRAGILE: HANDLE WITH CARE LOCATION: Outer carton (shipping box)	
KEEP DRY LOCATION: Outer carton (shipping box)	
TRANSPORTATION TEMPERATURE LIMITATIONS LOCATION: Outer carton (shipping box)	
HUMIDITY LIMITATIONS LOCATION: Outer carton (shipping box)	
ATMOSPHERIC PRESSURE LIMITATIONS LOCATION: Outer carton (shipping box)	

Appendix B: Tip Guide

NON-INITIATED

Tip	Name	Diameter	Length (mm)	Application	Part Number
	E4-4	400µm	4	Surgical	7400016
	E4-7	400µm	7	Perio	7410003/ 7400019
	E4-9	400µm	9	Perio	7410019
	E3-4	300 µm	4	Surgical	7400017
	E3-7	300µm	7	Perio	7410002/ 7400020
	E3-9	300µm	9	Perio	7400020

PRE-INITIATED

Tip	Name	Diameter	Length (mm)	Application	Part Number
	PI PRO 3-4	300µm	4	Surgical	7430001
	PI PRO 4-4	400µm	4	Surgical	7430002



NOTE: All BIOLASE Tips for diode lasers are sold non-sterile and are for single-use only. See Section 10 in this User Manual for cleaning and sterilization instructions.

Appendix C Accessories/Spare Parts

PART NO.	DESCRIPTION
6400105	Surgical Handpiece
2400277	Laser Safety Glasses
6400629	Fiber Optic Cable
6400622	Disposable Screen Protector (20/Pack)
6400616	Remote Interlock Connector
2400043	Power Cord (US)
2400055	Power Cord (Int'l)
6201667	Wireless Foot Pedal
7400022	Whitening Handpiece
6400463	Battery Pack, Foot Pedal (2 x AAA)
6400180	Disposable Shields for Whitening Handpiece (30/Pack)
7400030	Laserwhite20 Whitening Gel Kit (5/Pack)
7400063	Laserwhite20 Whitening Gel Kit (5/Pack) - Canada only
5400637	Danger Warning Sign

Appendix D Electromagnetic Compatibility



CAUTION: Medical electrical equipment needs special precautions regarding electromagnetic compatibility (EMC) and needs to be installed and put into service according to the EMC information provided in the following tables.

Portable and mobile Radio Frequency (RF) communications equipment can affect medical electrical equipment.

Accessories:

- Medical grade power cord, maximum length 3ft (1 meter), BIOLASE p/n 2400043 (US) BIOLASE p/n 2400055 (Int'l)
- Power Supply: BIOLASE p/n 2400272
- Wireless Foot Pedal: BIOLASE p/n 6201667



WARNING: The use of accessories, other than those specified, except those supplied or sold by BIOLASE, Inc. as replacement parts for internal or external components, may result in increased EMISSIONS or decreased IMMUNITY of the Epic Pro diode laser system.

GUIDANCE AND MANUFACTURER'S DECLARATION – ELECTROMAGNETIC EMISSIONS

The Epic Pro diode is intended for use in the electromagnetic environment specified below. The customer or the user of the Epic Pro diode should assure it is used in such an environment.

Emissions Test	Compliance	Electromagnetic environment - guidance
RF emissions CISPR 11	Group 1	The Epic Pro diode laser uses RF energy only for its internal function. Therefore, its RF emissions are very low and are not likely to cause any interference in nearby electronic equipment. The Epic Pro diode laser is suitable for use in all establishments other than domestic and those directly connected to the public low-voltage power supply network that supplies buildings used for domestic purposes.
RF emissions CISPR 11	Class A	
Harmonic emissions IEC 61000-3-2	Class A	
Voltage fluctuations/ flicker emissions IEC 61000-3-3	Class A	

Appendix D Electromagnetic Compatibility

GUIDANCE AND MANUFACTURER'S DECLARATION – ELECTROMAGNETIC IMMUNITY

The Epic Pro diode laser is intended for use in the electromagnetic environment specified below. The customer or the user of the Epic Pro diode should assure that it is used in such an environment.

Immunity test	IEC 60601 test level	Continuous level	Electromagnetic environment - guidance
Electrostatic discharge (ESD) IEC 61000-4-2	± 6 kV contact ± 8kV air	± 6 kV contact ± 8kV air	Floors should be wood, concrete or ceramic tile. If floors are covered with synthetic material, relative humidity should be at least 30%.
Electrical fast transient/burst IEC61000-4-4	± 2 kV for power supply lines ± 1 kV for input/output lines	± 2 kV for power supply lines N/A	Main power quality should be that of a typical commercial or hospital environment. Input/output that does not apply because the Foot Pedal cable length is less than 3 meters.
Surge IEC 61000-4-5	± 1 kV differential mode ± 2kV common mode	± 1 kV differential mode ± 2kV common mode	Main power quality should be that of a typical commercial or hospital environment.
Voltage dips, short interruptions and voltage variations on power supply input lines. IEC 61000-4-11	<5% Ur (>95% dip in UT) for 0.5 cycle 40% Ur (60% dip in UT) for 5 cycles 70% Ur (30% dip in Ur) for 25 cycles <5% Ur (>95% dip in Ur) for 5 seconds	<5% Ur (>95% dip in UT) for 0.5 cycle 40% Ur (60% dip in UT) for 5 cycles 70% Ur (30% dip in Ur) for 25 cycles <5% Ur (>95% dip in Ur) for 5 seconds	Main power quality should be that of a typical commercial or hospital environment. If the user of the Epic Pro diode requires continued operation during power main interruptions, it is recommended that the Epic Pro diode be powered from an uninterrupted power supply.
Power frequency (50-60 Hz) magnetic field IEC 61000-4-8	3 A/m	3 A/m	Power frequency magnetic fields should be at levels characteristic of a typical location in a typical commercial or hospital environment.

NOTE: Ur is the A.C. mains voltage prior to applications of the test level.

Appendix D Electromagnetic Compatibility

GUIDANCE AND MANUFACTURER'S DECLARATION – ELECTROMAGNETIC IMMUNITY

The Epic Pro is intended for use in the electromagnetic environment specified below. The customer or the user of the Epic Pro should assure that it is used in such an environment.

Immunity test	IEC 60601 test level	Continuous level	Electromagnetic environment - guidance
Conducted RF IEC 61000-4-6	3 Vrms 150 kHz to 80 GHz	3 V 3 Vm	<p>Portable and mobile RF communications equipment should be used no closer to any part of the Epic Pro diode laser, including cables, than the recommended separation distance calculated from the equation applicable to the frequency of the transmitter.</p> <p>Recommended separation distance</p> $d = 1.2\sqrt{P}$ $d = 1.2\sqrt{P} \quad 80 \text{ MHz to } 800 \text{ MHz}$ $d = 2.3\sqrt{P} \quad 800\text{MHz to } 2.5\text{GHZ}$ <p>Where P is the maximum output power rating of the transmitter in watts (W) according to the transmitter manufacturer and d is the recommended separation distance in meters (m).</p> <p>Field strengths from fixed RF transmitters, as determined by an electromagnetic site survey,^a should be less than the compliance level in each frequency range.^b</p> <p>Interference may occur in the vicinity of equipment marked with the following symbol:</p> 
Radiated RF IEC61000-4-3	3V/m 80 MHz to 2.5 GHz		

Appendix D Electromagnetic Compatibility

GUIDANCE AND MANUFACTURER'S DECLARATION – ELECTROMAGNETIC IMMUNITY

NOTE 1 - At 80 MHz and 800 MHz, the higher frequency range applies.

NOTE 2 – These guidelines may not apply in all situations. Electromagnetic propagation is affected by absorption and reflection from structures, objects, and people.

- a. Field strengths from fixed transmitters, such as base stations for radio (cellular/cordless) telephone and land mobile radios, amateur radio, AM and FM radio broadcast and TV broadcast cannot be predicted theoretically with accuracy. To assess the electromagnetic environment due to fixed RF transmitters, an electromagnetic site survey should be considered. If the measured field strength in the location in which the Epic Pro diode laser is used exceeds the applicable RF compliance level above, the Epic Pro diode laser should be observed to verify normal operation. If abnormal performance is observed, additional measures may be necessary, such as reorienting or relocating the Epic Pro diode laser.
- b. Over the frequency range 150 kHz to 80 MHz, field strengths should be less than [V1] V/m.

RECOMMENDED SEPARATION DISTANCES BETWEEN PORTABLE AND MOBILE RF COMMUNICATIONS EQUIPMENT AND THE EPIC DIODE LASER

The Epic Pro diode laser is intended for use in an electromagnetic environment in which radiated RF disturbances are controlled. The customer or the user of the Epic Pro diode can help prevent electromagnetic interferences by maintaining a minimum distance between portable and mobile RF communications equipment (transmitters) and the Epic Pro diode as recommended below, according to the maximum output power of the communications equipment.

Rated maximum output power of transmitter W	Separation distance according to frequency of transmitter M		
	150kHz to 80Mhz	80 MHz to 800 MHz	800 MHz to 2.5 GHz
	$d = 1.2\sqrt{P}$	$d = 1.2\sqrt{P}$	$d = 2.3\sqrt{P}$
0.01	0.12	0.12	0.23
0.1	0.38	0.38	0.73
1	1.2	1.2	2.3
10	3.8	3.8	7.3
100	12	12	23

For transmitters rated at a maximum output power not listed above, the recommended separation distance d in meters (m) can be estimated using the equation applicable to the frequency of the transmitter, where P is the maximum output power rating of the transmitter in watts (W) according to the transmitter manufacturer.

NOTE 1 – At 80 MHz and 800 MHz, the separation distance for the higher frequency range applies.

NOTE 2 – These guidelines may not apply in all situations. Electromagnetic propagation is affected by absorption and reflection from structures, objects, and people.

Appendix E Wireless Equipment Statement

This statement applies only to the wireless portion of the device:

This equipment has been tested and found to comply with the limits for a Class B digital device, pursuant to part 15 of the FCC Rules. These limits are designed to provide reasonable protection against harmful interference in a residential installation. This equipment generates, uses, and can radiate radio frequency energy and, if not installed and used in accordance with the instructions, may cause harmful interference to radio communications. However, there is no guarantee that interference will not occur in a particular installation. If this equipment does cause harmful interference to radio or television reception, which can be determined by turning the equipment off and on, the user is encouraged to try to correct the interference by one or more of the following measures:

- Reorient or relocate the receiving antenna
- Increase the separation between the equipment and receiver
- Connect the equipment into an outlet on a circuit different from that to which the receiver is connected
- Consult the dealer or an experienced radio/TV technician for help

FCC ID	OA3MRF24J40MA
IC ID	7693A-24J40MA
Type of Radio Equipment	Low Power Device (2400-2483.5 MHz)
Equipment Type	Radio Equipment (RE)
Min Power	475 uW
Max Power	475 uW
Field Strength	92dBuV

PAGE LEFT BLANK

BIOLASE

biolase.com

Epic pro



BIOLASE, INC.

27042 Towne Centre Drive, Suite 270
Foothill Ranch, CA 92610-2811

Telephone: (888) 424-6527

Telephone: (949) 361-1200

Fax: (949) 273-6687

Service: (800) 321-6717

MADE IN THE USA

©2020 BIOLASE, Inc. All rights reserved.

Epic Pro, Epic X, Epic, iLase, ezLase, ezTip, LaserWhite, Deep Tissue Handpiece, ComfortPulse, WaterLase, and WaterLase iPlus are either trademarks or registered trademarks of BIOLASE, Incorporated in the United States and/or other countries. All other trademarks are property of their registered owners. Subject to change without notice.

5400638 Rev. E

OFFICIAL DOCUMENT ONLY WHEN WATERMARK HERE